



■ **Silindirler**
Cylinders

■ **El Pompaları**
Hand Pumps

■ **Elektrikli Pompalar**
Electric Pumps

■ **Hidrolik Ayırıcılar**
Hydraulic Spreaders

■ **Tork Anahtarları**
Torque Wrench

HİDROLİK KRIKO ve EKİPMANLARI

HIGHT PRESSURE HYDRAULIC TOOLS AND EQUIPMENTS

PRATİK SİLİNDİR SEÇİM TABLOSU
CYLINDER QUICK SELECTION CHART

Kapasite Capacity (t)	Silindir Tipi Cylinder Type	Strok Stroke (mm)	Kapalı Yükseklik Collapsed Height (mm)	MODEL	Sayfa no
2.5	Çekiş Silindiri / Pulley Cylinder	127	265	ESP-25	142
	Tek Tesirli-Genel / Single Acting-General	16	41	ES-50	123
5	Tek Tesirli-Genel / Single Acting-General	25	110	ES-51	123
	Tek Tesirli-Genel / Single Acting-General	75	165	ES-53	123
	Tek Tesirli-Genel / Single Acting-General	127	216	ES-55	123
	Tek Tesirli-Genel / Single Acting-General	177	44	ES-57	123
	Tek Tesirli-Genel / Single Acting-General	232	324	ES-59	123
	Tesirli-Düşük Yük. / Single Acting-Low Height	6	33	ESL-50	124
	Çekiş Silindiri / Pulley Cylinder	140	302	ESP-46	142
	Tek Tesirli-Genel / Single Acting-General	26	90	ES-101	123
	Tek Tesirli-Genel / Single Acting-General	54	121	ES-102	123
	Tek Tesirli-Genel / Single Acting-General	105	171	ES-104	123
10	Tek Tesirli-Genel / Single Acting-General	156	248	ES-106	123
	Tek Tesirli-Genel / Single Acting-General	203	298	ES-108	123
	Tek Tesirli-Genel / Single Acting-General	257	349	ES-1010	123
	Tek Tesirli-Genel / Single Acting-General	304	400	ES-1012	123
	Tek Tesirli-Genel / Single Acting-General	356	451	ES-1014	123
	Tek Tesirli-Düşük Yük. / Single Acting-Low Height	10	43	ESL-100	124
	Tek Tesirli-Düşük Yük. / Single Acting-Low Height	38	88	ESL-101	126
	Çift Tesirli / Double Acting	254	409	ED-1010	132
	Çift Tesirli / Double Acting	305	457	ED-1012	132
	Çekiş Silindiri / Pulley Cylinder	151	587	ESP-106C	142
13	Çekiş Silindiri / Pulley Cylinder	151	542	ESP-106L	142
	Çekiş Silindiri / Pulley Cylinder	151	289	ESP-106	142
	Tek Tesirli - Ortası Delik / Single Acting - Hollow	8	55	ESH-120	128
	Tek Tesirli - Ortası Delik / Single Acting - Hollow	42	120	ESH-121	128
	Tek Tesirli - Ortası Delik / Single Acting - Hollow	76	184	ESH-123	128
	Tek Tesirli-Genel / Single Acting-General	25	124	ES-151	123
	Tek Tesirli-Genel / Single Acting-General	51	149	ES-152	123
	Tek Tesirli-Genel / Single Acting-General	101	200	ES-154	123
	Tek Tesirli-Genel / Single Acting-General	152	272	ES-156	123
	Tek Tesirli-Genel / Single Acting-General	203	322	ES-158	123
15	Tek Tesirli-Genel / Single Acting-General	254	373	ES-1510	123
	Tek Tesirli-Genel / Single Acting-General	305	424	ES-1512	123
	Tek Tesirli-Genel / Single Acting-General	356	475	ES-1514	123
	Tek Tesirli-Düşük Yük. / Single Acting-Low Height	11	52	ESL-200	124
	Tek Tesirli-Düşük Yük. / Single Acting-Low Height	45	99	ESL-201	126
	Tek Tesirli-Alüminyum / Single Acting-Aluminum	54.10	162	ESA-202	127
	Tek Tesirli-Alüminyum / Single Acting-Aluminum	104.90	213	ESA-204	127
	Tek Tesirli-Alüminyum / Single Acting-Aluminum	155.95	263	ESA-206	127
	Tek Tesirli - Ortası Delik / Single Acting - Hollow	49	162	ESH-202	128
	Tek Tesirli - Ortası Delik / Single Acting - Hollow	155	306	ESH-206	128
20	Tek Tesirli-Genel / Single Acting-General	26	140	ES-251	123
	Tek Tesirli-Genel / Single Acting-General	50	165	ES-252	123
	Tek Tesirli-Genel / Single Acting-General	102	216	ES-254	123
	Tek Tesirli-Genel / Single Acting-General	158	273	ES-256	123
	Tek Tesirli-Genel / Single Acting-General	210	324	ES-258	123
	Tek Tesirli-Genel / Single Acting-General	261	375	ES-2510	123
	Tek Tesirli-Genel / Single Acting-General	311	425	ES-2512	123
	Tek Tesirli-Genel / Single Acting-General	362	476	ES-2514	123
	Tek Tesirli-Genel / Single Acting-General	209	387	ES-308	123
	Tek Tesirli-Düşük Yük. / Single Acting-Low Height	13	59	ESL-300	124
25	Tek Tesirli-Düşük Yük. / Single Acting-Low Height	62	118	ESL-302	126
	Tek Tesirli-Alüminyum / Single Acting-Aluminum	54.10	187	ESA-302	127
	Tek Tesirli-Alüminyum / Single Acting-Aluminum	104.90	238	ESA-304	127
	Tek Tesirli-Alüminyum / Single Acting-Aluminum	155.95	289	ESA-306	127
	Tek Tesirli - Ortası Delik / Single Acting - Hollow	64	179	ESH-302	128
	Tek Tesirli - Ortası Delik / Single Acting - Hollow	155	330	ESH-306	128
	Çift Tesirli / Double Acting - Hollow	178	330	EDH-307	130
	Çift Tesirli - Ortası Delik / Double Acting - Hollow	258	431	EDH-3010	130
	Çift Tesirli / Double Acting	209	387	ED-308	132

Kapasite Capacity (t)	Silindir Tipi Cylinder Type	Strok Stroke (mm)	Kapalı Yükseklik Collapsed Height (mm)	MODEL	Sayfa no
30	Çift Tesirli / Double Acting	368	546	ED-3014	132
	Çekiş Silindiri / Pulley Cylinder	155	1085	ESP-306	143
50	Tek Tesirli-Düşük Yük. / Single Acting-Low Height	16	67	ESL-500	124
	Tek Tesirli-Düşük Yük. / Single Acting-Low Height	60	122	ESL-502	126
	Tek Tesirli-Genel / Single Acting-General	51	176	ES-502	123
	Tek Tesirli-Genel / Single Acting-General	102	227	ES-504	123
	Tek Tesirli-Genel / Single Acting-General	159	283	ES-506	123
	Tek Tesirli-Genel / Single Acting-General	337	461	ES-5013	123
	Tek Tesirli-Alüminyum / Single Acting-Aluminum	54.10	171	ESA-552	127
	Tek Tesirli-Alüminyum / Single Acting-Aluminum	104.90	223	ESA-554	127
	Tek Tesirli-Alüminyum / Single Acting-Aluminum	155.95	272	ESA-556	127
	Tek Tesirli-Em.somunlu-Alü. / S.Acting-Lock-Al	152.4	318	ELA-556	138
75	Çift Tesirli / Double Acting	156	331	ED-506	132
	Çift Tesirli / Double Acting	334	509	ED-5013	132
	Çift Tesirli / Double Acting	511	733	ED-5020	132
	Tek Tesirli-Yüksek Tonaj / Single Acting-High Ton.	50	162	ESX-502	134
	Tek Tesirli-Yüksek Tonaj / Single Acting-High Ton.	100	212	ESX-504	134
	Tek Tesirli-Yüksek Tonaj / Single Acting-High Ton.	150	262	ESX-506	134
	Tek Tesirli-Yüksek Tonaj / Single Acting-High Ton.	200	312	ESX-508	134
	Tek Tesirli-Yüksek Tonaj / Single Acting-High Ton.	250	362	ESX-5010	134
	Yüksek Tonaj / Single Acting-High Ton.	300	412	ESX-5012	134
	Çift Tesirli-Yüksek Tonaj / Double Acting-High Ton.	50	162	EDX-502	136
100	Çift Tesirli-Yüksek Tonaj / Double Acting-High Ton.	100	212	EDX-504	136
	Çift Tesirli-Yüksek Tonaj / Double Acting-High Ton.	150	262	EDX-506	136
	Çift Tesirli-Yüksek Tonaj / Double Acting-High Ton.	200	312	EDX-508	136
	Çift Tesirli-Yüksek Tonaj / Double Acting-High Ton.	250	362	EDX-510	136
	Çift Tesirli-Yüksek Tonaj / Double Acting-High Ton.	300	412	EDX-5012	136
	Tek Tesirli-Emniyet somunu / Single Acting-Lock	50	164	EL-502	141
	Tek Tesirli-Emniyet somunu / Single Acting-Lock	100	214	EL-504	141
	Tek Tesirli-Emniyet somunu / Single Acting-Lock	150	264	EL-506	141
	Tek Tesirli-Emniyet somunu / Single Acting-Lock	200	314	EL-508	141
	Tek Tesirli-Emniyet somunu / Single Acting-Lock	250	364	EL-5010	141
130	Tek Tesirli-Emniyet somunu / Single Acting-Lock	300	414	EL-5012	141
	Çekiş Silindiri / Pulley Cylinder	152	720	ESP-606	142
	Tek Tesirli - Ortası Delik / Single Acting - Hollow	76	247	ESH-603	128
	Tek Tesirli - Ortası Delik / Single Acting - Hollow	153	323	ESH-606	128
	Çift Tesirli - Ortası Delik / Double Acting - Hollow	89	247	EDH-603	130
	Çift Tesirli - Ortası Delik / Double Acting - Hollow	166	323	EDH-606	130
	Çift Tesirli - Ortası Delik / Double Acting - Hollow	257	438	EDH-6010	130
	Tek Tesirli-Düşük yükseklik-Emniyet somunu / Single Acting-Low Height-Lock	50	125	ELL-602	139
	Tek Tesirli-Genel / Single Acting-General	156	286	ES-756	123
	Tek Tesirli-Genel / Single Acting-General	333	492	ES-7513	123
150	Tek Tesirli-Düşük Yük. / Single Acting-Low Height	16	80	ESL-750	124
	Çift Tesirli / Double Acting	156	347	ED-756	132
	Çift Tesirli / Double Acting	333	525	ED-7513	132
	Tek Tesirli-Genel / Single Acting-General	168	357	ES-1006	123
	Tek Tesirli-Genel / Single Acting-General	260	449	ES-10010	123
	Tek Tesirli - Ortası Delik / Single Acting - Hollow	76	254	ESH-1003	128
	Çift Tesirli - Ortası Delik / Double Acting - Hollow	38	165	EDH-1001	128
	Çift Tesirli - Ortası Delik / Double Acting - Hollow	76	254	EDH-1003	128
	Çift Tesirli - Ortası Delik / Double Acting - Hollow	153	342	EDH-1006	128
	Çift Tesirli - Ortası Delik / Double Acting - Hollow	257	460	EDH-10010	128
200	Çift Tesirli / Double Acting	168	357	ED-1006	128
	Çift Tesirli / Double Acting	333	524	ED-10013	132
	Çift Tesirli / Double Acting	460	687	ED-10018	132
	Tek Tesirli-Düşük Yük. / Single Acting-Low Height	16	86	ESL-1000	124
	Tek Tesirli-Düşük Yük. / Single Acting-Low Height	57	141	ESL-1002	126
	Tek Tesirli-Alüminyum / Single Acting-Aluminum	54.10	197	ESA-1002	127
	Tek Tesirli-Alüminyum / Single Acting-Aluminum	159	298	ESA-1006	127
	Tek Tesirli-Yüksek Tonaj / Single Acting-High Ton.	50	182	ESX-1002	134
	Tek Tesirli-Yüksek Tonaj / Single Acting-High Ton.	100	232	ESX-1004	134

HİDROLİK KRİKO ve EKİP.
High Pressure Hydraulic Tools
And Equipments

PRATİK SİLİNDİR SEÇİM TABLOSU
CYLINDER QUICK SELECTION CHART

Kapasite Capacity (t)	Silindir Tipi Cylinder Type	Strok Stroke (mm)	Kapalı Yükseklik Collapsed Height (mm)	MODEL	Sayı no	
100	Tek Tesirli-Yüksek Tona / Single Acting-High Ton.	150	282	ESX-1006	134	
	Tek Tesirli-Yüksek Tona / Single Acting-High Ton.	200	332	ESX-1008	134	
	Tek Tesirli-Yüksek Tona / Single Acting-High Ton.	250	382	ESX-10010	134	
	Tek Tesirli-Yüksek Tona / Single Acting-High Ton.	300	432	ESX-10012	134	
	Tek Tesirli-Emmiyet somunu / Single Acting-Lock	50	187	EL-1002	141	
	Tek Tesirli-Emmiyet somunu / Single Acting-Lock	100	237	EL-1004	141	
	Tek Tesirli-Emmiyet somunu / Single Acting-Lock	150	287	EL-1006	141	
	Tek Tesirli-Emmiyet somunu / Single Acting-Lock	200	337	EL-1008	141	
	Tek Tesirli-Emmiyet somunu / Single Acting-Lock	250	387	EL-10010	141	
	Tek Tesirli-Emmiyet somunu / Single Acting-Lock	300	437	EL-10012	141	
	Çift Tesirli-Yüksek Tona / Double Acting-High Ton.	50	179	EDX-1002	136	
	Çift Tesirli-Yüksek Tona / Double Acting-High Ton.	100	229	EDX-1004	136	
	Çift Tesirli-Yüksek Tona / Double Acting-High Ton.	150	279	EDX-1006	136	
	Çift Tesirli-Yüksek Tona / Double Acting-High Ton.	200	329	EDX-1008	136	
140	Çift Tesirli-Yüksek Tona / Double Acting-High Ton.	250	379	EDX-10010	136	
	Çift Tesirli-Yüksek Tona / Double Acting-High Ton.	300	429	EDX-10012	136	
	Tek Tesirli-Düşük yükseklik - Emmiyet somunu / Single Acting-Low Height-Lock	50	137	EL-1002	139	
	Tek Tesirli-Emmiyet somunu-Alüminyum / Single Acting-Lock - Aluminum	152.4	340	ELA-1006	138	
	Çift Tesirli / Double Acting	57	196	ED-1502	132	
	Çift Tesirli / Double Acting	156	385	ED-1506	132	
	Çift Tesirli / Double Acting	333	582	ED-15013	132	
	Çift Tesirli - Ortası Delik / Double Acting - Hollow	203	349	EDH-1508	130	
	Tek Tesirli-Yüksek Tona / Single Acting-High Ton.	50	196	ESX-1502	128	
	Tek Tesirli-Yüksek Tona / Single Acting-High Ton.	100	246	ESX-1504	134	
	Tek Tesirli-Yüksek Tona / Single Acting-High Ton.	150	296	ESX-1506	134	
	Tek Tesirli-Yüksek Tona / Single Acting-High Ton.	200	346	ESX-1508	134	
	Tek Tesirli-Yüksek Tona / Single Acting-High Ton.	250	396	ESX-15010	134	
	Tek Tesirli-Yüksek Tona / Single Acting-High Ton.	300	446	ESX-15012	134	
150	Tek Tesirli-Emmiyet somunu / Single Acting-Lock	50	209	EL-1502	141	
	Tek Tesirli-Emmiyet somunu / Single Acting-Lock	100	259	EL-1504	141	
	Tek Tesirli-Emmiyet somunu / Single Acting-Lock	150	309	EL-1506	141	
	Tek Tesirli-Emmiyet somunu / Single Acting-Lock	200	359	EL-1508	141	
	Tek Tesirli-Emmiyet somunu / Single Acting-Lock	250	409	EL-15010	141	
	Tek Tesirli-Emmiyet somunu / Single Acting-Lock	300	459	EL-15012	141	
	Tek Tesirli-Düşük Yük / Single Acting-Low Height	16	100	ESL-1500	126	
	Çift Tesirli-Yüksek Tona / Double Acting-High Ton.	50	196	EDX-1502	136	
	Çift Tesirli-Yüksek Tona / Double Acting-High Ton.	100	246	EDX-1504	136	
	Çift Tesirli-Yüksek Tona / Double Acting-High Ton.	150	296	EDX-1506	136	
	Çift Tesirli-Yüksek Tona / Double Acting-High Ton.	200	346	EDX-1508	136	
	Çift Tesirli-Yüksek Tona / Double Acting-High Ton.	250	396	EDX-15010	136	
	Çift Tesirli-Yüksek Tona / Double Acting-High Ton.	300	446	EDX-15012	136	
	160	Tek Tesirli-Düşük yükseklik - Emmiyet somunu / Single Acting-Low Height-Lock	45	148	ELL-1602	139
Tek Tesirli-Emmiyet somunu / Single - Lock		50	243	EL-2002	141	
Tek Tesirli-Emmiyet somunu / Single - Lock		150	343	EL-2006	141	
Tek Tesirli-Emmiyet somunu / Single - Lock		250	443	EL-20010	141	
Çift Tesirli / Double Acting		152	430	ED-2006	132	
Çift Tesirli / Double Acting		330	608	ED-20013	132	
Tek Tesirli-Yüksek Tona / Single Acting-High Ton.		50	216	ESX-2002	134	
Tek Tesirli-Yüksek Tona / Single Acting-High Ton.		150	316	ESX-2006	134	
Tek Tesirli-Yüksek Tona / Single Acting-High Ton.		300	466	ESX-20012	134	
Çift Tesirli-Yüksek Tona / Double Acting-High Ton.		50	212	EDX-2002	136	
Çift Tesirli-Yüksek Tona / Double Acting-High Ton.		150	312	EDX-2006	136	
Çift Tesirli-Yüksek Tona / Double Acting-High Ton.		300	462	EDX-20012	136	
Tek Tesirli-Düşük yükseklik - Emmiyet somunu / Single Acting-Low Height-Lock		45	155	ELL-2002	136	
Tek Tesirli-Yüksek Tona / Single Acting-High Ton.		50	235	ESX-2502	134	
200	Tek Tesirli-Yüksek Tona / Single Acting-High Ton.	150	335	ESX-2506	134	
	Tek Tesirli-Yüksek Tona / Single Acting-High Ton.	300	485	ESX-25012	134	
	Çift Tesirli-Yüksek Tona / Double Acting-High Ton.	50	235	EDX-2502	136	
	Çift Tesirli-Yüksek Tona / Double Acting-High Ton.	150	335	EDX-2506	136	
	Çift Tesirli-Yüksek Tona / Double Acting-High Ton.	300	485	EDX-25012	136	
	250	Tek Tesirli-Emmiyet somunu / Single Acting-Lock	50	249	EL-2502	141

Kapasite Capacity (t)	Silindir Tipi Cylinder Type	Strok Stroke (mm)	Kapalı Yükseklik Collapsed Height (mm)	MODEL	Sayı no
250	Tek Tesirli-Emmiyet somunu / Single Acting-Lock	150	349	EL-2506	141
	Tek Tesirli-Emmiyet somunu / Single Acting-Lock	250	449	EL-25010	141
260	Tek Tesirli-Düşük yükseklik - Emmiyet somunu / Single Acting-Low Height-Lock	45	159	ELL-2502	139
	Çift Tesirli / Double Acting	153	485	ED-3006	132
300	Tek Tesirli-Yüksek Tona / Single Acting-High Ton.	50	312	ESX-3002	134
	Tek Tesirli-Yüksek Tona / Single Acting-High Ton.	150	412	ESX-3006	134
	Tek Tesirli-Yüksek Tona / Single Acting-High Ton.	300	562	ESX-30012	134
	Çift Tesirli-Yüksek Tona / Double Acting-High Ton.	50	322	EDX-3002	136
	Çift Tesirli-Yüksek Tona / Double Acting-High Ton.	150	422	EDX-3006	136
	Çift Tesirli-Yüksek Tona / Double Acting-High Ton.	300	572	EDX-30012	136
	Tek Tesirli-Emmiyet somunu / Single Acting-Lock	50	295	EL-3002	141
	Tek Tesirli-Emmiyet somunu / Single Acting-Lock	150	395	EL-3006	141
	Tek Tesirli-Emmiyet somunu / Single Acting-Lock	250	495	EL-30010	141
	Tek Tesirli-Emmiyet somunu / Single Acting-Lock	50	335	EL-4002	141
	Tek Tesirli-Emmiyet somunu / Single Acting-Lock	150	435	EL-4006	141
	Tek Tesirli-Emmiyet somunu / Single Acting-Lock	250	535	EL-40010	141
	Tek Tesirli-Yüksek Tona / Single Acting-High Ton.	50	375	ESX-4002	134
	Tek Tesirli-Yüksek Tona / Single Acting-High Ton.	150	475	ESX-4006	134
400	Tek Tesirli-Yüksek Tona / Single Acting-High Ton.	300	625	ESX-40012	134
	Çift Tesirli-Yüksek Tona / Double Acting-High Ton.	50	374	EDX-4002	136
	Çift Tesirli-Yüksek Tona / Double Acting-High Ton.	150	474	EDX-4006	136
	Çift Tesirli-Yüksek Tona / Double Acting-High Ton.	300	624	EDX-40012	136
	Tek Tesirli-Düşük yükseklik - Emmiyet somunu / Single Acting-Low Height-Lock	45	178	ELL-4002	139
	Tek Tesirli-Yüksek Tona / Single Acting-High Ton.	50	419	ESX-5002	134
	Tek Tesirli-Yüksek Tona / Single Acting-High Ton.	150	519	ESX-5006	134
	Tek Tesirli-Yüksek Tona / Single Acting-High Ton.	300	669	ESX-50012	134
	Çift Tesirli-Yüksek Tona / Double Acting-High Ton.	50	419	EDX-5002	136
	Çift Tesirli-Yüksek Tona / Double Acting-High Ton.	150	519	EDX-5006	136
	Çift Tesirli-Yüksek Tona / Double Acting-High Ton.	300	669	EDX-50012	136
	Tek Tesirli-Emmiyet somunu / Single Acting-Lock	50	375	EL-5002	141
	Tek Tesirli-Emmiyet somunu / Single Acting-Lock	150	475	EL-5006	141
	Tek Tesirli-Emmiyet somunu / Single Acting-Lock	250	575	EL-50010	141
500	Tek Tesirli-Düşük yükseklik - Emmiyet somunu / Single Acting-Low Height-Lock	45	192	ELL-5002	139
	Tek Tesirli-Yüksek Tona / Single Acting-High Ton.	50	429	ESX-6002	134
	Tek Tesirli-Yüksek Tona / Single Acting-High Ton.	150	529	ESX-6006	134
	Tek Tesirli-Yüksek Tona / Single Acting-High Ton.	300	679	ESX-60012	134
	Çift Tesirli-Yüksek Tona / Double Acting-High Ton.	50	429	EDX-6002	136
	Çift Tesirli-Yüksek Tona / Double Acting-High Ton.	150	529	EDX-6006	136
	Çift Tesirli-Yüksek Tona / Double Acting-High Ton.	300	679	EDX-60012	136
	Tek Tesirli-Emmiyet somunu / Single Acting-Lock	50	395	EL-6002	141
	Tek Tesirli-Emmiyet somunu / Single Acting-Lock	150	495	EL-6006	141
	Tek Tesirli-Emmiyet somunu / Single Acting-Lock	250	595	EL-60010	141
	Tek Tesirli-Yüksek Tona / Single Acting-High Ton.	50	474	ESX-8002	134
	Tek Tesirli-Yüksek Tona / Single Acting-High Ton.	150	574	ESX-8006	134
	Tek Tesirli-Yüksek Tona / Single Acting-High Ton.	300	724	ESX-80012	134
	Çift Tesirli-Yüksek Tona / Double Acting-High Ton.	50	484	EDX-8002	136
Çift Tesirli-Yüksek Tona / Double Acting-High Ton.	150	584	EDX-8006	136	
Çift Tesirli-Yüksek Tona / Double Acting-High Ton.	300	734	EDX-80012	136	
600	Tek Tesirli-Emmiyet somunu / Single Acting-Lock	50	455	EL-8002	141
	Tek Tesirli-Emmiyet somunu / Single Acting-Lock	150	555	EL-8006	141
	Tek Tesirli-Emmiyet somunu / Single Acting-Lock	250	655	EL-80010	141
	Tek Tesirli-Yüksek Tona / Single Acting-High Ton.	50	564	ESX-10002	134
	Tek Tesirli-Yüksek Tona / Single Acting-High Ton.	150	664	ESX-10006	134
	Tek Tesirli-Yüksek Tona / Single Acting-High Ton.	300	814	ESX-100012	134
	Çift Tesirli-Yüksek Tona / Double Acting-High Ton.	50	564	EDX-10002	136
	Çift Tesirli-Yüksek Tona / Double Acting-High Ton.	150	663	EDX-10006	136
	Çift Tesirli-Yüksek Tona / Double Acting-High Ton.	300	814	EDX-100012	136
	Tek Tesirli-Emmiyet somunu / Single Acting-Lock	50	495	EL-10002	141
	Tek Tesirli-Emmiyet somunu / Single Acting-Lock	150	595	EL-10006	141
	Tek Tesirli-Emmiyet somunu / Single Acting-Lock	250	695	EL-10010	141

HİDROLİK KRİKO ve EKİPMANLAR
High Pressure Hydraulic Tools
And Equipments

ES SERİSİ / ES SERIES

GENEL AMAÇLI TEK TESİRLİ SİLİNDİRLER / GENERAL PURPOSE, SINGLE ACTING CYLINDERS



Soldan sağa doğru modeller / Shown from left to right
ES-1010, ES-256, ES-252, ES-10010,
ES-504, ES-59, ES 2510

Opsiyonel Oynar Piston Başlığı / Optional Tilt Saddle

Kullanılacak Silindirin Kapasitesi / For use with Cylinder Capacity	Oynar Piston Başlığı Modeli / Tilt Saddle Model	Kullanılacak Silindirin Kapasitesi / For use with Cylinder Capacity	Oynar Piston Başlığı Modeli / Tilt Saddle Model
Metric Ton / Metric Ton (US Ton)*		Metric Ton / Metric Ton (US Ton)*	
5 (5.5)	-	30 (33)	ST-50
10 (11)*	ST-10	50 (55)	ST-100
15 (16.5)	ST-10	75 (82.5)	ST-100
25 (27.5)	ST-50	95 (102.3)	ST-100

* ES-101 dışında

Özellikler

- ASME B-30.1 regülasyonuna uygundur. Yüksek kalite çelik alalım sayesinde emniyet ve dayanıklılık artırılmıştır.
- Sertleştirilmiş ve krom kaplanmış piston sayesinde dayanıklılık artırılarak aşınma indirgenmiştir.
- Kolay sabitlemeyi gerçekleştirmek için sıkma bileziği dişleri, piston dişleri ve gövde montaj delikleri.
- Ağır yük pistonu çekme yayları.
- EAB 201 yüksek kalite çabuk bağlantı rakorları.
- Çevre dostu boya ile korozyon dayanımı sağlamıştır.

Features

- Complies with ASME B-30.1. High strength steel for durability and increased safety.
- Hardened and chromed piston increase durability and reduces wear.
- Collar threads, piston threads and base mounting holes enable easy fixturing.
- Heavy-duty piston return springs.
- High quality EAB 201 quick couplers.
- Environmentally friendly painting process provides a durable anti-corrosion finish.



- **Yüksek basınç hortumlarını seçiniz.**
Quality pressure hoses



- **EV-23 ile birlikte kullanılması önerilen yük taşıyıcı manuel kontrol valfi.**
Use with EV-23 manually operated check valve for load holding.



- **Aşırı yüklenmeleri önlemek için sistemin çalışma basıncını kontrol etmeye yarayan göstergesi seçiniz.**
Pressure gauges vaible to monitor system pressure.

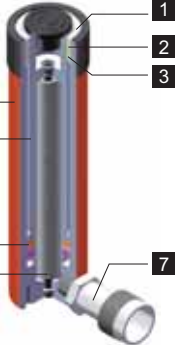

1. Kılavuz halka merkez dışı yüklere karşı koruma, destek sağlar ve fazla yükselmeye engel olur.
2. Silindirin toz ve kirlere korunmasını sağlamak, performansını ve servis ömrünü artırmak için toz contası
3. Merkezlenmemiş yüklerde aşınmayı engellemek ve ek destek sağlayan şaft bileziği.
4. Yüksek dayanıma sahip emaye kaplı çelik gövde dayanıklılık için kaplanmış.
5. Sertleştirilmiş ve krom kaplanmış piston sayesinde dayanıklılık artırılarak aşınma indirgenmiştir.
6. Sızıntıları önleyen sızdırmaz conta ve endüstriyel keçe.
7. Tüm silindirlere ağır hizmet toz kapaklı standart bağlantı rakorları.
8. Yüksek dayanıklı dönüş yayı.

1. Guide Ring eliminates over travel, and provides support to reduce wear from off center loads.
2. Heavy duty wiper ring keep duts and debris out of cylinder body, improving performance and service life of cylinder.
3. Bearing ring provides additional support to reduce wear from center loads.
4. All steel body with baked enamel finish for durability.
5. Hardened and chromed piston increase durability and reduces wear.
6. Secondary gasket and industrial seal ring assembly prevent costly leaks.
7. Standard coupler on all cylinders provided with heavy duty dust cover.
8. High strength return spring.



106 adet ES-306 tek tesirli silindirler, stator çekirdeği tutucu laminenin preslenmesinde kullanılmıştır.



106 pieces of ES-306 single acting cylinders are used to press the laminates into stator core hold-down gear.

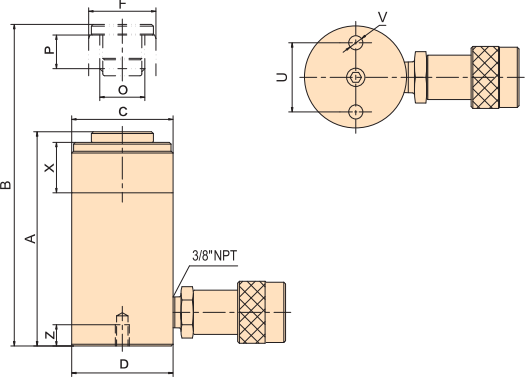

Art. No. / Cod No.	Silindir Kapasitesi Ø700bar (10,000 PSI) Cylinder Capacity (10,000 PSI)	Strok / Stroke	Model	Silindir Etkelik Alanı / Cylinder Effective Area	Yağ Kapasitesi Oil Capacity	İnmiş Durumda Yükseklik / Collapsed Height		Genişleşmiş Durumda Yükseklik / Extended Height		Gövde Diş Çapı / Collar Diam	Gövde Diş Uzunluğu Collar Thread Length	Diş Çapı / Outside Diameter	Piston Mil Çapı Piston Rod Diam.	Piston İç Diş Piston Internal Thread	Piston Diş Uzunluğu/ Piston Thread Length	Tutucu Civ. Delikleri / Base Fix Holes			Ağırlık / Weight
						A mm	B mm	C in	X mm							D mm	F mm	O -	
91100001	5	16	ES-50	7,1	11,5	42	58	—	—	59 x 42	25	—	—	—	—	28	0,22	—	0,8
91100002		25	ES-51	7,1	17,9	110	135	1 1/2"-16	28	38	25	3/4"-16 UNF	16	25	1/4"-20	14	1,0	1,8	
91100003		75	ES-53	7,1	53,3	165	240	1 1/2"-16	28	38	25	3/4"-16 UNF	16	25	1/4"-20	14	1,3	2,0	
91100004		127	ES-55	7,1	90,2	215	342	1 1/2"-16	28	38	25	3/4"-16 UNF	16	25	1/4"-20	14	1,7	2,5	
91100005		177	ES-57	7,1	125,8	273	450	1 1/2"-16	28	38	25	3/4"-16 UNF	16	25	1/4"-20	14	2,1	3,0	
91100006	232	ES-59	7,1	164,8	323	555	1 1/2"-16	28	38	25	3/4"-16 UNF	16	25	1/4"-20	14	2,3	3,3		
91100007	10	26	ES-101	14,5	37,7	89	115	2 1/4"-14	26	57	38	1"-8 UNC	6	39	5/16"-18	11,9	1,7	1,7	
91100008		54	ES-102	14,5	78,4	121	175	2 1/4"-14	26	57	38	1"-8 UNC	19	39	5/16"-185/16"	11,9	2,2	2,2	
91100009		105	ES-104	14,5	152,4	171	276	2 1/4"-14	26	57	38	1"-8 UNC	19	39	16"-185/16"	11,9	2,9	2,9	
91100010		156	ES-106	14,5	226,3	247	403	2 1/4"-14	28	57	38	1"-8 UNC	19	39	6"-185/16"	11,9	4,1	4,1	
91100011		203	ES-108	14,5	294,5	298	501	2 1/4"-14	26	57	38	1"-8 UNC	19	39	"-185/16"	11,9	4,9	4,9	
91100012		257	ES-1010	14,5	372,8	349	606	2 1/4"-14	28	57	38	1"-8 UNC	19	39	185/16"-1	11,9	5,6	5,6	
91100013		304	ES-1012	14,5	441,0	400	704	2 1/4"-14	26	57	38	1"-8 UNC	19	39	85/16"-10	11,9	6,4	6,4	
91100014		356	ES-1014	14,5	516,4	450	806	2 1/4"-14	26	57	38	1"-8 UNC	19	39	3/8"-16	11,9	7,2	7,2	
91100015		25	ES-151	21,2	53,0	124	149	2 3/4"-16	35	70	42	1"-8 UNC	25	47	3/8"-16	11,9	3,2	3,2	
91100016		51	ES-152	21,2	108,2	149	200	2 3/4"-16	35	70	42	1"-8 UNC	25	47	3/8"-16	11,9	3,7	3,7	
91100017	15	101	ES-154	21,2	214,2	200	301	2 3/4"-16	35	70	42	1"-8 UNC	25	47	3/8"-16	11,9	5,0	5,0	
91100018		152	ES-156	21,2	322,4	271	423	2 3/4"-16	35	70	42	1"-8 UNC	25	47	3/8"-16	11,9	6,5	6,5	
91100019		203	ES-158	21,2	430,5	322	525	2 3/4"-16	35	70	42	1"-8 UNC	25	47	3/8"-16	11,9	7,7	7,7	
91100020		254	ES-1510	21,2	538,7	373	627	2 3/4"-16	35	70	42	1"-8 UNC	25	47	3/8"-16	11,9	8,7	8,7	
91100021		305	ES-1512	21,2	646,8	423	728	2 3/4"-16	35	70	42	1"-8 UNC	25	47	3/8"-16	11,9	9,8	9,8	
91100022		356	ES-1514	21,2	755,1	474	830	2 3/4"-16	35	70	42	1"-8 UNC	25	47	1/2"-13	11,9	10,8	10,8	
91100023		26	ES-251	33,2	86,4	139	165	3 5/16"-12	54	86	57	1 1/2"-16 UN	26	58	1/2"-13	19,1	5,3	5,3	
91100024		50	ES-252	33,2	166,1	165	215	3 5/16"-12	54	86	57	1 1/2"-16 UN	26	58	1/2"-13	19,1	6,2	6,2	
91100025	25	102	ES-254	33,2	338,8	215	317	3 5/16"-12	54	86	57	1 1/2"-16 UN	26	58	1/2"-13	19,1	8,0	8,0	
91100026		158	ES-256	33,2	524,8	273	431	3 5/16"-12	54	86	57	1 1/2"-16 UN	26	58	1/2"-13	19,1	10,3	10,3	
91100027		210	ES-258	33,2	697,5	323	533	3 5/16"-12	54	86	57	1 1/2"-16 UN	26	58	1/2"-13	19,1	12,1	12,1	
91100028		261	ES-2510	33,2	866,9	374	635	3 5/16"-12	54	86	57	1 1/2"-16 UN	26	58	1/2"-13	19,1	14,1	14,1	
91100029		311	ES-2512	33,2	1032,9	425	736	3 5/16"-12	54	86	57	1 1/2"-16 UN	26	58	1/2"-13	19,1	15,5	15,5	
91100030	362	ES-2514	33,2	1202,3	476	838	3 5/16"-12	54	86	57	1 1/2"-16 UN	26	58	—	—	19,1	17,4	17,4	
91100031	30	209	ES-308	44,2	924,1	387	596	3 5/16"-12	50	105	57	1 1/2"-16 UN	26	60	1/2"-13	—	21,5	21,5	
91100032		51	ES-502	70,9	361,8	176	227	5"-12	55	127	80	—	—	95	1/2"-13	19,1	14,4	14,4	
91100033		102	ES-504	70,9	723,4	227	329	5"-12	55	127	80	—	—	95	1/2"-13	19,1	18,1	18,1	
91100034	50	159	ES-506	70,9	1127,8	282	441	5"-12	55	127	80	—	—	95	1/2"-13	19,1	22,2	22,2	
91100035		337	ES-5013	70,9	2390,3	460	797	5"-12	55	127	80	—	—	95	—	19,1	34,3	34,3	
91100036		156	ES-756	103,9	1621,5	285	441	5 3/4"-12	45	146	95	—	—	—	—	—	—	30,5	30,5
91100037	75	333	ES-7513	103,9	3461,2	492	825	5 3/4"-12	45	146	95	—	—	—	3/4"-10	—	50,3	50,3	
91100038		168	ES-1006	133	2235,3	357	525	6 7/8"-12	44	177	105	—	—	—	139	3/4"-10	24,9	59,6	59,6
91100039	260	ES-10010	133	3459,4	449	709	6 7/8"-12	44	177	105	—	—	—	139	—	24,9	72,8	72,8	

HİDROLİK KRİKO ve Ekipmanlar
High Pressure Hydraulic Tools
And Equipments

ESL SERİSİ / ESL SERIES

TEK TESİRLİ DÜŞÜK YÜKSEKLİKLİ SİLİNDİRLER SINGLE ACTING, LOW HEIGHT CYLINDERS



Soldan sağa doğru modeller / Shown from left to right
ESL-1002, ESL-302, ESL-500, ESL-50, ESL-300

Özellikler

- Sınırlı alanlarda kullanım kolaylığı sağlar.
- ASME B-30.1 regülasyonuna uygundur.
- Yüksek kalite çelik alaşım sayesinde emniyet ve dayanıklılık artırmıştır.
- Montaj delikleri kolayca sabitlemenizi sağlar.
- Ağır yük pistonu çekme yayları.
- EAB 201 yüksek kalite çabuk bağlantı rakorları.
- Yivli piston yapısı, piston başlığı gerektirmez.
- Çevre dostu boya ile korozyon dayanımı sağlanmıştır.

Features

- Use in confined spaces.
- Complies with ASME B-30.1. High strength steel for durability and increased safety.
- Mounting holes permit easy fixturing.
- Heavy-duty piston return springs.
- High quality EAB 201 quick couplers.
- Grooved piston end requires no saddle.
- Environmentally friendly painting process provides a durable anti-corrosion finish.

Kod No / Code No	Silindir Kapasitesi @700bar / Cylinder Capacity (10,000 PSI)	Strok / Stroke	Model	Silindir Etketif Alanı / Cylinder Effective Area	Yağ Kapasitesi / Oil Capacity	Genişleşmiş Durumda / Yükseklik / Extended Height	
						Inmiş Durumda Yükseklik / Collapsed Height	A
	ton	mm		cm ²	cm ³	mm	mm
91110001	5	6	ESL-50*	7,1	4,3	33	39
91110002	10	10	ESL-100	14,5	14,4	42	53
91110003	20	11	ESL-200	28,3	31,2	51	62
91110004	30	13	ESL-300	41,8	54,3	58	71
91110005	50	16	ESL-500	63,6	101,8	67	83
91110006	75	16	ESL-750	103,9	166,3	79	95
91110007	100	16	ESL-1000	132,7	212,5	86	102
91110008	150	16	ESL-1500	201,1	321,9	100	116

ESL SERİSİ / ESL SERIES

Köprüyü istenen pozisyona getirmek için elektrik pompaları ile birlikte 24 adet silindir kullanılmıştır.

24 hydraulic cylinders with an electric hydraulic pump lift a bridge into position.

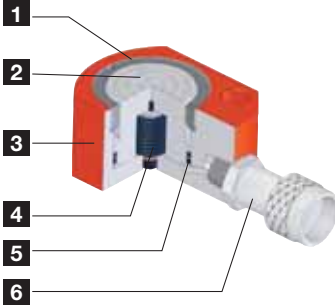

1. Kılavuz halka merkez dışı yüklerle karşı koruma, destek sağlar ve fazla yükselmeye engel olur.
2. Sertleştirilmiş ve krom kaplanmış piston sayesinde dayanıklılık artırılarak aşınma indirgenmiştir.
3. Yüksek dayanıma sahip emaye kaplı çelik gövde dayanıklılık için kaplanmıştır.
4. Yüksek dayanıklı dönüş yayı.
5. Sızıntıları önleyen sızdırmaz conta ve endüstriyel keçe.
6. Tüm silindirlere ağır hizmet toz kapaklı standart bağlantı rakorları.

1. Steel guide ring eliminates over travel and withstands full dead end load, it also provides support to reduce wear from off center loads.
2. Hardened and chromed piston increase durability and reduces wear.
3. All steel body with baked enamel finish for durability.
4. High strength return spring.
5. Secondary gasket and industrial seal ring assembly prevent costly leaks.
6. Standard coupler on all cylinders provided with heavy duty dust cover.

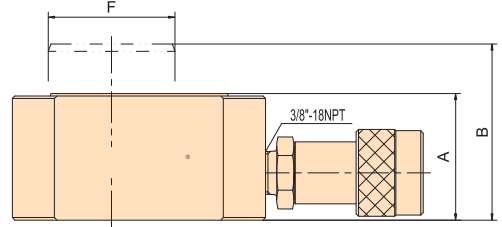
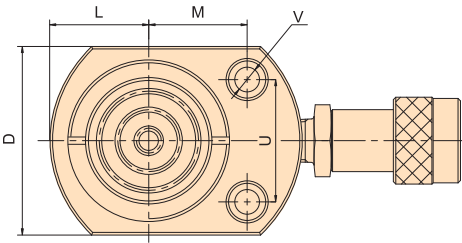

Not: ESL-50 de EAB 203A kaplin, diğer modellerde EAB 201A kaplin kullanılmıştır.
ESL-50 has EAB-203A coupler, the other models have EAB-201A coupler.

Dış Çap / Outside Diameter	Piston Mil Çapı / Piston Rod Diam.	Üst Ölçüler / Upside Dimension					Ağırlık / Weight
		M	L	V	U		
D	F	M	L	V	U		
mm	mm	mm	mm	mm	mm	kg	
59 x 42	25	23	21	5,6	28,4	0,6	
83 x 56	38	34	28	7,1	36,6	1,5	
102 x 76	51	40	40	19,9	49,3	2,7	
117 x 95	66	45	48	9,9	52,1	4,3	
140 x 114	70	54	57	10,9	66,5	6,7	
165 x 139	83	66	69	13,5	76,2	11,4	
178 x 153	92	74	76	13,5	76,2	14,5	
215 x 190	115	82	95	13,5	117,3	26,3	

ESL SERİSİ / ESL SERIES

Özellikler

- Düşük yükseklik ve özellikli tasarımı ile sınırlı çalışma alanlarında kullanım olanağı sağlar.
- ASME B-30.1 regülasyonuna uygundur. Yüksek kalite çelik alaşım sayesinde emniyet ve dayanıklılık artırmıştır.
- Tek tesirli, dönüş yayı.
- EAB 201 yüksek kalite çabuk bağlantı rakorları.
- Oynar piston başlığı montajı için civata delikli oluklu piston uçları.
- Çevre dostu boya ile korozyon dayanımı sağlanmıştır.

Features

- Low profile design for use in confined spaces.
- Complies with ASME B-30.1. High strength steel for durability and increased safety.
- Single-acting spring return.
- High quality EAB 201 quick couplers.
- Grooved piston ram with threaded holes for mounting tilt saddles.
- Environmentally friendly painting process provides a durable anti-corrosion finish.

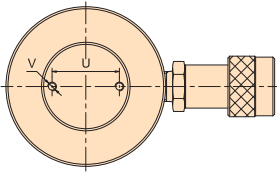
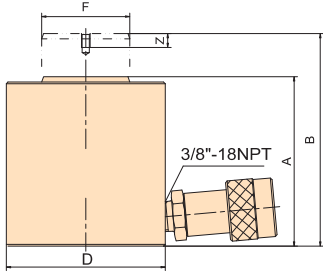

Opsiyonel Oynar Piston Başlığı /

Optional Tilt Saddle

Silindir Model / Cylinder Model	Oynar Piston Başlığı Modeli / Tilt Saddle Model
ESL-101	ST-11
ESL- 201, 302, 502	ST-51
ESL-1002	ST-101

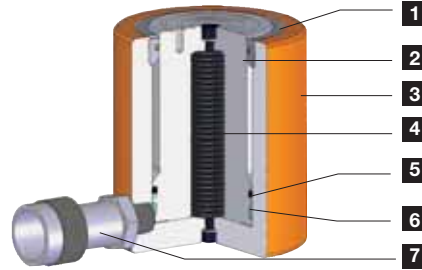

1. Kılavuz halka merkez dışı yüklerle karşı koruma, destek sağlar ve fazla yükselmeye engel olur.
2. Sertleştirilmiş ve krom kaplanmış piston sayesinde dayanıklılık artırılarak aşınma indirgenmiştir.
3. Yüksek dayanıma sahip emaye kaplı çelik gövde dayanıklılık için kaplanmıştır.
4. Yüksek dayanıklı dönüş yayı.
5. Sızıntıları önleyen endüstriyel keçe.
6. Merkezlenmemiş yüklerde aşınmayı engellemek ve ek destek sağlayan şaft bileziği.
7. Tüm silindirlere ağır hizmet toz kapaklı standart bağlantı rakorları.

1. Steel guide ring eliminates over travel and provides additional support to reduce wear from off center loads.
2. Hardened and chromed piston increase durability and reduces wear.
3. All steel body with baked enamel finish for durability.
4. High strength return spring.
5. Industrial seal ring assembly prevent costly leaks.
6. Bearing ring provides additional support to reduce wear from off center loads.
7. Standard coupler on all cylinders provided with heavy duty dust cover.

Kod no / Code No	Silindir Kapasitesi @700bar Cylinder Effective Capacity	Strok / Stroke mm	Model	Silindir Etkif Alanı / Cylinder Effective Area cm ²	Yağ Kapasitesi / Oil Capacity cm ³	İnmiş Durumda Yükseklik / Collapsed Height mm	Genişlemiş Durumda Yükseklik/ Extended Height mm	Dış Çap / Outside Diameter mm	Piston Mil Çapı / Piston Rod Diam. mm	Üst Ölçüler/ Upside Dimension			Ağırlık / Weight kg
										Dış / Thread mm	Civata Mrk.mes. Bolt Circle mm	Dış Derinliği / Thread Depth mm	
91110009	10	38	ESL-101	14,4	54,8	88	126	69	38	M4	26	8	4,1
91110010	20	45	ESL-201	28,3	127,4	98	143	92	51	M5	39	8	4,7
91110011	30	62	ESL-302	41,8	259,3	117	179	102	66	M5	39	8	6,8
91110012	50	60	ESL-502	63,6	381,8	122	182	124	70	M5	39	8	10,1
91110013	100	57	ESL-1002	132,7	757,2	141	198	165	92	M8	55	11	19,2

ESA SERİSİ / ESA SERIES**TEK TESİRLİ ALÜMİNYUM SİLİNDİRLER**
SINGLE ACTING, ALUMINUM CYLINDERS

Soldan sağa doğru modeller / Shown from left to right
ESA-202 / ESA-304

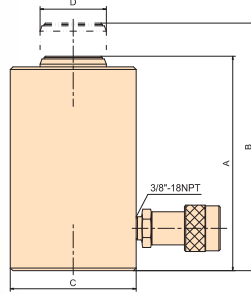
**Özellikler**

- Düşük ağırlıkta ve taşınması kolay.
- Korozyon ve aşınma dayanımına sahip ve özel işlemlerden geçirilmiş yüksek mukavemetli alüminyum malzeme.
- Zor çevresel şartlarda kullanım olanağı.
- Tek tesirli, dönüş yayı.

Features

- Low weight, easy to carry.
- High strength aluminum material treated to resist wear and corrosion.
- For use in extreme environment.
- Single acting, spring return.

1. Kılavuz halka pistonun limitinde durmasını sağlar ve merkezlenmemiş yüklerde destek görevi üstlenir.
2. Yüksek mukavemetli alüminyum alaşımlı gövde korozyona karşı koruma sağlayacak şekilde kaplanmıştır.
3. Yüksek mukavemetli, düz inen dönüş yayı hızlı hareket eder.
4. Ürün üzerinde toz kapaklı standart kaplin bulunur.
5. Yüksek mukavemetli kompozit rulmanlar merkezlenmemiş yüklerle karşı destek görevi sağlar ve silindir duvarlarının hasar görmesini önler.

1. Guide ring allows the piston to stop at its limit and it acts as a support for decentralized loads.
2. High strength aluminum alloy body is resistant to corrosion coated to protect against.
3. High strength, flat descending return spring moves fast.
4. There is a standard coupling with dust cover on the product.
5. High strength composite bearings are not centered provides support against loads and ensures that the cylinder wall prevents damage.

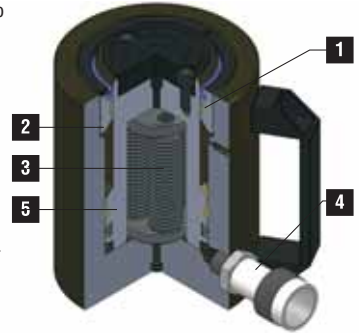

Kod no / Code No	Silindir Kapasitesi @700bar Cylinder Capacity	Strok / Stroke	Model	Silindir Etkelil Alanı / Cylinder Effective Area	Yağ Kapasitesi / Oil Capacity	Inmiş Durumda Yükseklik / Collapsed Height	Genişleşmiş Durumda Yükseklik/ Extended Height	Dış Çap / Outside Diameter	Piston Mil Çapı / Piston Rod Diam.	Ağırlık / Weight
				cm ²	cm ³	A mm	B mm	C mm	D mm	kg
91120001	20	54	ESA-202	28,3	152,9	162	216	95	50	3,5
91120002		105	ESA-204	28,3	297,3	213	318	95	50	4,3
91120003		156	ESA-206	28,3	441,48	263	420	95	50	5,2
91120004	30	54	ESA-302	44,2	238,7	188	242	109	65	5,2
91120005		105	ESA-304	44,2	464,3	238	343	109	65	6,1
91120006		156	ESA-306	44,2	689,8	289	445	109	65	7,6
91120007	50	54	ESA-552	70,9	382,9	172	226	134	80	7,2
91120008		105	ESA-554	70,9	744,7	222	327	134	80	8,9
91120009		156	ESA-556	70,9	1106,5	273	429	134	80	10,9
91120010	100	54	ESA-1002	133,0	718,5	197	251	188	105	15,8
91120011		159	ESA-1006	133,0	2115,6	299	458	188	105	22,5

ESH SERİSİ / ESH SERIES

TEK TESİRLİ ORTASI DELİK SİLİNDİRLER SINGLE ACTING HOLLOW CENTER CYLINDERS



ESH-302

ESH-120

Özellikler

- Delikli piston tasarımı itme ve çekme güçlerine izin verir.
- ASME B-30.1 regülasyonuna uygundur.
Yüksek kalite çelik alaşım sayesinde emniyet ve dayanıklılık artırılmıştır.
- Tek tesirli, dönüş yayı.
- EAB 201 yüksek kalite çabuk bağlantı rakorları.
- Kolay monte edilebilen sıkma bileziği dişleri ve piston.
- Çevre dostu boya ile korozyon dayanımı sağlanmıştır.

Features

- Hollow piston design allows for both pull and push forces.
- Complies with ASME B-30.1. High strength steel for durability and increased safety.
- Single acting, spring return.
- High quality EAB 201 quick couplers.
- Collar threads, piston threads for easy fixturing.
- Environmentally friendly painting process provides a durable anti-corrosion finish.

Opsiyonel Isıl İşlemli Ortası Delik Başlık / Optional Heat Treated Hollow Saddles

Silindir Model / Cylinder Model	Oynar Piston Başlığı Modeli / Tilt Saddle Model	Oynar Piston Başlığı Ölçüleri / Saddle Dimensions			
		A	B	V	D
		mm	in	mm	in
ESH-202,206	SH-2015	55	1"-8UNC	9	1 9/16"-16UN
ESH-302,306	SH-3015	63	1 1/4"-7UN	9	1 13/16"-16UN
ESH-603,606	SH-5016	91	1 5/8"-5 1/2UN	12	2 3/4"-16UN
ESH-1003	SH-10016	126	2 1/2"-8UN	12	4"-16UN

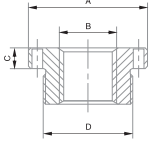

Kod no / Code No	Silindir Kapasitesi @700bar Cylinder Capacity	Strok / Stroke	Model	Silindir Etkelir Alanı / Cylinder Effective Area	Yağ Kapasitesi / Oil Capacity	Inmiş Durumda Yükseklik / Collapsed Height	Genişleşmiş Durumda Yükseklik/ Extended Height	Sıkma Gövde/ Collar Thread	Gövde Diş Uzu. / Collar Thread Length	Diş Çap / Outside Diameter
						A	B	C	X	D
	ton	mm		cm ²	cm ³	mm	mm	in	mm	mm
91130001	13	8	ESH-120*	18,5	14,8	55	63	2 3/4"-16	30	70
91130002		42	ESH-121*	18,5	77,7	120	162	2 3/4"-16	30	70
91130004		76	ESH-123*	18,5	140,6	184	260	2 3/4"-16	30	70
91130005	20	49	ESH-202	32,8	160,7	162	211	3 7/8"-12	38	99
91130006		155	ESH-206	32,8	508,6	306	461	3 7/8"-12	38	99
91130007	30	64	ESH-302	47,7	305,4	178	242	4 1/2"-12	42	115
91130008		155	ESH-306	47,7	739,6	330	485	4 1/2"-12	42	115
91130009	60	76	ESH-603	87,5	665,4	246	322	6 1/4"-12	48	159
91130010		153	ESH-606	87,5	1338,2	323	476	6 1/4"-12	48	159
91130011	95	76	ESH-1003	135,3	1028,8	254	330	8 3/8"-12	60	212

*NOT: ESH-120, ESH-121 ve ESH-123 üzerine EAB 202A kaplin ve 1/4" NPT port vardır.
Diğer modellerde EAB201A kaplin ve 3/8" NPT port vardır.

ESH SERİSİ / ESH SERIES

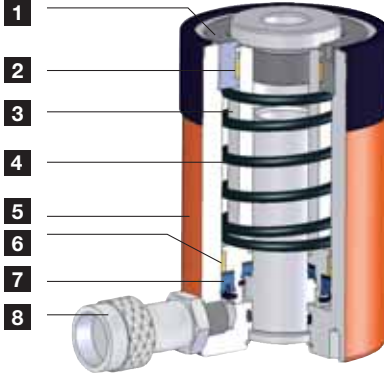

1. Kılavuz halka merkez dışı yüklerle karşı koruma, destek sağlar ve fazla yükselmeye engel olur.
2. Merkezlenmemiş yüklerde aşınmayı engellemek ve ek destek sağlayan şaft bileziği.
3. Sertleştirilmiş ve krom kaplanmış piston sayesinde dayanıklılık artırılarak aşınma indirilmiştir.
4. Yüksek dayanıklı dönüş yayı.
5. Yüksek dayanıma sahip emaye kaplı çelik gövde dayanıklılık için kaplanmıştır.
6. Merkezlenmemiş yüklerde aşınmayı engellemek ve ek destek sağlayan şaft bileziği.
7. Sızıntıları önleyen endüstriyel keçe.
8. Tüm silindirlerde ağır hizmet toz kapaklı standart bağlantı rakorları.

1. Steel guide ring eliminates over travel and provides additional support to reduce wear from off center loads.
2. Bearing ring provides additional support to reduce wear from off center loads.
3. Hardened and chromed piston increase durability and reduces wear.
4. High strength return spring.
5. All steel body with baked enamel finish for durability.
6. Industrial bearing ring provides additional support to reduce wear from off center loads.
7. Industrial seal ring assembly prevent costly leaks.
8. Standard coupler on all cylinders provided with heavy duty dust cover.



SONDEX firmasındaki eşanjörlerde H serisi ürünler kullanılmaktadır.

ESH series are being used to pull the threaded bar on the largest heat-exchanger in SONDEX's factory.

Piston Mil Çapı / Piston Rod Diam.	Piston İç Diş Çapı / Outside/Inside Diameter	Piston Dış Uzunluğu / Piston Thread	Tutucu Cıvata Delikleri			Merkez Deliği Çapı / Center Hole Dimanter	Ağırlık / Weight
			Cıvata Merk. Mesafesi / Bolt Circle	Diş / Thread	Diş Derinliği / Thread Depth		
F		P	U	V	Z	Y	
mm	in	mm	mm	mm	mm	mm	kg
35	3/4"-16UN	16	51	5/16"-18	9	20	1,5
35	-	-	—	—	—	20	2,8
35	-	-	51	5/16"-18	9	20	4,4
55	1-9/16"-16UN	19	83	3/8"-16	9	27	7,3
55	1-9/16"-16UN	19	83	3/8"-16	9	27	13,4
65	1-13/16"-16UN	22	92	3/8"-16	14	33	10,5
65	1-13/16"-16UN	22	92	3/8"-16	14	33	19,3
92	2-3/4"-16UN	19	130	1/2"-13	14	54	27,4
92	2-3/4"-16UN	19	130	1/2"-13	14	54	34,8
127	4"-16UN	25	178	5/8"-11	20	79	59,4

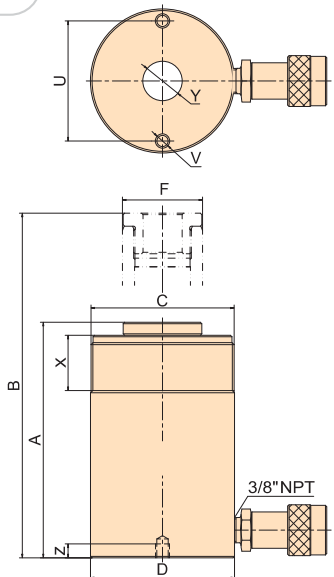

EDH SERİSİ / EDH SERIES

ÇİFT TESİRLİ ORTASI DELİK SİLİNDİRLER DOUBLE ACTING, HOLLOW CENTER CYLINDERS



Soldan sağa doğru modeller / Shown from left to right
EDH-3010, EDH-603, EDH-6010

Özellikler

- Delikli piston tasarımı itme ve çekme güçlerine izin verir.
- ASME B-30.1 regülasyonuna uygundur. Yüksek kalite çelik alaşım sayesinde emniyet ve dayanıklılık artırılmıştır.
- Hızlı iniş için çift tesirli işleyiş.
- Gövde üzerindeki emniyet vanası aşırı basınç yüklenmesinde meydana gelebilecek kazaları engeller.
- EAB 201 yüksek kalite çabuk bağlantı rakorları.
- Kolay monte edilebilir sıkıma bileziği dişleri ve piston.
- Çevre dostu boya ile korozyon dayanımı sağlanmıştır.

Features

- Hollow piston design allows for both pulling and pushing actions.
- Complies with ASME B-30.1. High strength steel for durability and increased safety.
- Double acting operation for fast piston retraction.
- Built-in safety valve prevents accidental over-pressurization.
- High quality EAB 201 quick couplers.
- Collar and piston threads for easy fixturing.
- Environmentally friendly painting process provides a durable corrosion resistant finish.

Opsiyonel Isıl İşlemli Ortası Delik Başlık / Optional Heat Treated Hollow Saddles

Silindir Model / Cylinder Model	Piston Model Numarası / Saddle Model Number	Oynar Piston Başlığı Ölçüleri / Saddle Dimensions			
		A	B	C	D
		mm	in	mm	in
EDH-307,3010	SH-3015	63	1 1/4"-7UN	9	1 13/16"-16UN
EDH-603,606,6010	SH-5016	91	1 5/8"-5 1/2UN	12	2 3/4"-16UN
EDH-1001, 1003, 1006, 10010	SH-10016	126	2 1/2"-8UN	12	4"-16UN

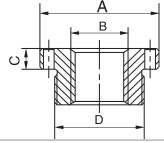

Kod no / Code No	Silindir Kapasitesi @700bar Cylinder Capacity (10.000 PSI)	Strok / Stroke mm	Model	Maks.Silindir Kapasitesi / Max.Cylinder Capacity		Silindir Efektif Alanı / Cylinder Effective Area		Yağ Kapasitesi / Oil Capacity		İnmiş Durumda Yükseklik / Collapsed Height A
				İleri / Advance ton	Geri/ Retract ton	İleri / Advance cm ²	Geri / Retract cm ²	İleri / Advance cm ³	Geri / Retract cm ³	
				ton	ton	cm ²	cm ²	cm ³	cm ³	
91140001	30	178	EDH-307	36	25	47,7	32,4	849,4	577,3	330
91140002		258	EDH-3010	36	25	47,7	32,4	1231,2	836,4	431
91140003	60	89	EDH-603	66	43	87,5	56,2	779,0	481,2	246
91140004		166	EDH-606	66	43	87,5	56,2	1453,0	891,3	323
91140005		257	EDH-6010	66	43	87,5	56,2	2249,6	1388,6	438
91140006		38	EDH-1001	102	66	135,3	87,1	514,3	331,1	165
91140007	95	76	EDH-1003	102	66	135,3	87,1	1028,8	662,2	254
91140008		153	EDH-1006	102	66	135,3	87,1	2071,0	1333,5	342
91140009		257	EDH-10010	102	66	135,3	87,1	3478,6	2239,9	460
91140010	150	203	EDH-1508	149	64	197,0	102,0	4000,8	2074,8	349

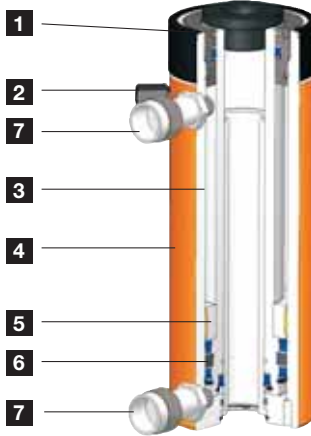
EDH SERİSİ / EDH SERIES

1. Kılavuz halka merkez dışı yüklerle karşı koruma, destek sağlar ve fazla yükselmeye engel olur.
2. Aşırı yüklenmeyi önlemek için emniyet valfi otomatik tahliye sistemi devreye girer.
3. Sertleştirilmiş ve krom kaplanmış piston sayesinde dayanıklılık artırılarak aşınma indirgenmiştir.
4. Yüksek dayanıma sahip emaye kaplı çelik gövde dayanıklılık için kaplanmıştır.
5. Merkezlenmemiş yüklerde aşınmayı engellemek ve ek destek sağlayan şaft bileziği.
6. Sızıntıları önleyen endüstriyel keçe.
7. Tüm silindirlerde ağır hizmet toz kapaklı standart bağlantı rakorları.

1. Steel guide ring eliminates over travel and also provides support to reduce wear from off center loads.
2. Safety valve automatic release the pressure to avoid overload.
3. Hardened and chromed piston increase durability and reduces wear.
4. All steel body with baked enamel finish for durability.
5. Industrial bearing ring provides additional support to reduce wear from off center loads.
6. Industrial seal ring assembly prevent costly leaks.
7. Standard coupler on all cylinders provided with heavy duty dust cover.

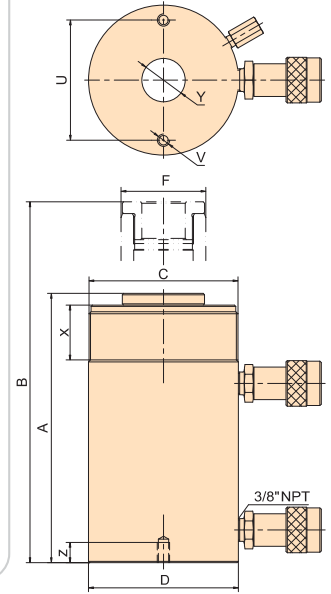

Genişleşmiş Durumda Yükseklik/ Extended Height	Sıkma Gövde/ Collar Thread		Dış Çap / Outside Diameter	Piston Mil Çapı / Piston Rod Diam.	Piston İç Dış Çapı / Piston Outside / Inside Diameter	Piston Dış Uzunluğu / Piston Thread	Tutucu Civata Delikleri / Base Fix Holes			Merkez Delikli Çap/ Center Hole Diameter	Ağırlık / Weight	
	B	X					D	F	O			P
	mm	in	mm	mm	mm	mm	mm	mm	in	mm	mm	kg
508	4 1/2"-12 UN	42	115	65	1 13/16"-16	559	92	3/8"-16 UNC	15,5	33,3	18,3	
689	4 1/2"-12 UN	42	115	65	1 13/16"-16	559	92	3/8"-16 UNC	15,5	33,3	24,5	
335	6 1/4"-12 UNC	48	159	92	2 3/4"-16	483	130	1/2"-13 UNC	14	53,8	27,2	
489	6 1/4"-12 UNC	48	159	92	2 3/4"-16	483	130	1/2"-13 UNC	14	53,8	34,2	
695	6 1/4"-12 UNC	48	159	92	2 3/4"-16	635	130	1/2"-13 UNC	14	53,8	46,9	
203	8 3/8"-12 UN	—	212	127	4"-16	635	178	5/8"-11 UNC	20	79	37,0	
330	8 3/8"-12 UN	60	212	127	4"-16	635	178	5/8"-11 UNC	20,1	79	55,4	
495	8 3/8"-12 UN	60	212	127	4"-16	635	178	5/8"-11 UNC	20,1	79	70,9	
717	8 3/8"-12 UN	60	212	127	4"-16	635	178	5/8"-11 UNC	20,1	79	92,4	
552	—	—	247	150	4 1/4"-12	635	—	—	—	79,2	102,9	

ED SERİSİ / ED SERIES

ÇİFT TESİRLİ SİLİNDİRLER DOUBLE ACTING CYLINDERS

Soldan sağa
doğru modeller /
Shown from left to right
ED-506, ED-7513



Özellikler

- ASME B-30.1 regülasyonuna uygundur. Yüksek kalite çelik alaşım sayesinde emniyet ve dayanıklılık artırılmıştır.
- Hızlı iniş için çift tesirli işleyiş.
- Gövde üzerindeki emniyet vanası aşırı basınç yüklenmesinde meydana gelebilecek kazaları engeller.
- EAB 201 yüksek kalite çabuk bağlantı rakorları.
- Kolay monte edilebilir sıkma bileziği dişleri ve piston.
- Çevre dostu boya ile korozyon dayanımı sağlanmıştır.

Features

- Complies with ASME B-30.1. High strength steel for durability and increased safety.
- Double acting operation for fast retractinon.
- Built-in safety valve prevents accidental over-pressurization.
- High quality EAB 201 quick couplers.
- Collar and piston threads for easy fixturing.
- Environmentally friendly painting process provides a durable corrosion resistant finish.

Opsiyonel Oynar Piston Başlığı / Optional Tilt Saddle

Silindir Model / Cylinder Model	Oynar Piston Başlığı Modeli / Tilt Saddle Model
ED-308, 3014	ST-50
ED-506, 5013, 5020, 756, 7513	ST-100

Kod no / Code No	Silindir Kapasitesi @700bar Cylinder Capacity (10.000 PSI) ton	Strok / Stroke mm	Model	Maks.Silindir Kapasitesi / Max.Cylinder Capacity		Silindir Etketif Alanı / Cylinder Effective Area		Yağ Kapasitesi / Oil Capacity	
				İleri / Advance	Geri/Retract	İleri / Advance	Geri / Retract	İleri / Advance	Geri / Retract
				ton	ton	cm2	cm2	cm3	cm3
91150001	10 (11)	254	ED-1010	10 (11)	4 (4,4)	14,5	4,9	368,5	124,5
91150002		305	ED-1012	10 (11)	4 (4,4)	14,5	4,9	442,5	149,6
91150003	30 (33)	209	ED-308	30 (33)	6 (6,6)	41,9	18,1	876,1	378,5
91150004		368	ED-3014	30 (33)	6 (6,6)	41,9	18,1	1542,6	666,3
91150005	50 (55)	156	ED-506	50 (55)	16 (17,6)	70,9	20,6	1106,5	321,4
91150006		334	ED-5013	50 (55)	16 (17,6)	70,9	20,6	2368,0	688,3
91150007		511	ED-5020	50 (55)	16 (17,6)	70,9	20,6	3624,4	1053,0
91150008		156	ED-756	75 (82,5)	25 (27,5)	103,9	33	1621,5	515,0
91150009	75 (82.5)	333	ED-7513	75 (82,5)	25 (27,5)	103,9	33	3461,2	1099,3
91150010		168	ED-1006	95 (104,5)	48 (52,8)	133	61,9	2235,3	1040,4
91150011	95 (104.5)	333	ED-10013	95 (104,5)	48 (52,8)	133	61,9	4430,6	2061,1
91150012		460	ED-10018	95 (104,5)	48 (52,8)	133	61,9	6120,5	2847,5
91150013		57	ED-1502	140 (154)	75 (82,5)	201	97,2	1146,2	554,3
91150014	140 (154)	156	ED-1506	140 (154)	75 (82,5)	201	97,2	3136,8	1517,3
91150015		333	ED-15013	140 (154)	75 (82,5)	201	97,2	6696,0	3238,0
91150017	200 (220)	152	ED-2006	200 (220)	108(118,8)	283,4	140,4	4310,9	2135,1
91150018		330	ED-20013	200 (220)	108(118,8)	283,4	140,4	9359,3	4635,1
91150019		300	ED-3006	300 (330)	184(202,4)	452,3	238,6	6924,4	3652,1

ED SERİSİ / ED SERIES

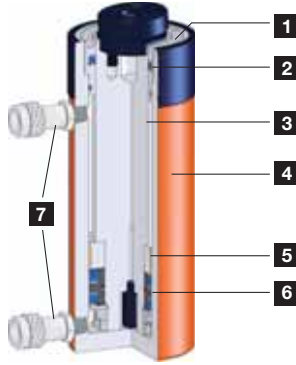

1. Kılavuz halka merkez dışı yüklerle karşı koruma, destek sağlar ve fazla yükselmeye engel olur.
2. Sızıntıları önleyen endüstriyel keçe.
3. Sertleştirilmiş ve krom kaplanmış piston sayesinde dayanıklılık artırılarak aşınma indirgenmiştir.
4. Yüksek dayanıma sahip emaye kaplı çelik gövde dayanıklılık için kaplanmıştır.
5. Merkezlenmemiş yüklerde aşınmayı engellemek ve ek destek sağlayan şaft bileziği.
6. Sızıntıları önleyen endüstriyel keçe.
7. Tüm silindirlere ağır hizmet toz kapaklı standart bağlantı rakorları.

1. Steel guide ring eliminates over travel and also provides additional support to reduce wear from off center loads.
2. Industrial seal ring assembly prevent costly leaks.
3. Hardened and chromed piston increase durability and reduces wear.
4. All steel body with baked enamel finish for durability.
5. Industrial bearing ring provides additional support to reduce wear from off center loads.
6. Industrial seal ring assembly prevent costly leaks.
7. Standard coupler on all cylinders provided with heavy duty dust cover.

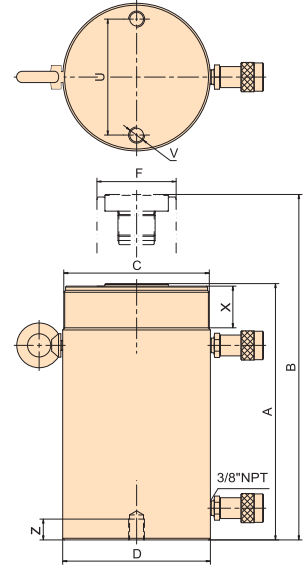

Elektrik santralinde çıkışın geçit üzerine bağlanmasında 56 adet ED-308 kullanıldı.
56 pieces of ED-308 used to flange the gate on the track in generation station.

İnmiş Durumda Yükseklik / Collapsed Height	Genişlemiş Durumda Yükseklik/ Extended Height	Sıkma Gövde/ Collar Thread	Sıkma Gövde Uzunluğu / Collar Thread Length	Dış Çap / Outside Diameter	Piston Mil Çapı / Piston Rod Diam.	Tutucu Cıvata Delikleri / Base Fix Holes			Ağırlık / Weight
						Çap / Diameter	Diş / Thread	Diş Derinliği/ Thread Depth	
A	B	C	X	D	F	U	V	Z	kg
mm	mm	in	mm	mm	mm	mm	in	mm	
409	663	2 1/4"-14	26	73	35	—	—	—	12
457	762	2 1/4"-14	26	73	35	—	—	—	14
387	596	3 5/16"-12	49	105	55	—	—	—	20
549	917	3 5/16"-12	49	105	55	—	—	—	31
331	487	5"-12	44	127	80	—	—	—	30
509	843	5"-12	44	127	80	—	—	—	51,9
733	1244	5"-12	44	132	80	76	1/2"-13UNC	25	69,9
347	503	5 3/4"-12	38	146	95	—	—	—	41
525	858	5 3/4"-12	38	146	95	—	—	—	67,9
357	525	6 7/8"-12	50	177	95	139	3/4"-10UNC	25	60,9
524	857	6 7/8"-12	50	177	95	139	3/4"-10UNC	25	92,9
687	1147	6 7/8"-12	50	177	95	139	3/4"-10UNC	25	116,9
196	253	8"-12	—	204	115	—	—	—	48,9
385	541	8"-12	55	204	115	158	3/4"-16UNC	28	92,9
582	915	8"-12	55	204	115	158	3/4"-16UNC	28	123,9
430	582	9 3/4"-12	—	249	135	127	1"-8UNC	25	146,8
608	938	9 3/4"-12	54	249	135	127	1"-8UNC	25	198,8
485	638	12 1/4"-12	58	312	165	158	1 1/4"-7UNC	44	199,8

ESX SERİSİ / ESX SERIES

TEK TESİRLİ YÜKSEK TONAJLI SİLİNDİRLER SINGLE ACTING, HIGH TONNAGE CYLINDERS



Soldan sağa doğru modeller / Shown from left to right
ESX-506, ESX-2002, ESX 1008

Özellikler

- ASME B-30.1 regülasyonuna uygundur. Yüksek dayanıma sahip çelik alaşım ilave emniyet sistemi sağlar.
- Montaj kolaylığı sağlayan vidalı yapı.
- Taşıma kolaylığı sağlayan mapa ve mapa yuvası.
- EAB 201 yüksek kalite, çabuk bağlantı rakorları.
- Çevre dostu boya ile korozyon dayanımı sağlanmıştır.
- Tek tesirli yük geri dönüşlü silindir.
- Eğim yatak kovanları mevcuttur.

Features

- Complies with ASME B-30.1. High grade steel cylinder is heat treated for additional strength.
- Threaded base easier to install.
- Threaded hole & rigging easier to carry.
- High flow EAB 201 quick coupler.
- Environmentally friendly painting process provides a durable corrosion resistant finish.
- Single acting, load return.
- Tilt saddle available.

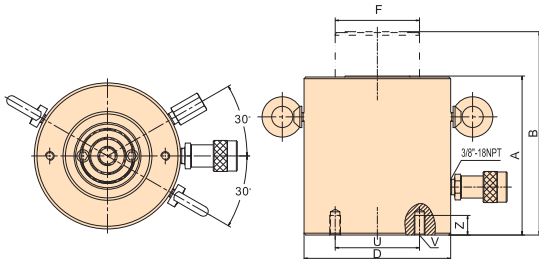

Kod no / Code No	Silindir Kapasitesi @700bar Cylinder Capacity (10.000 PSI)	Strok / Stroke	Model	Silindir Etkelil Alanı / Cylinder Effective Area
		ton		mm
91160001	50	50	ESX-502	75,4
91160002		100	ESX-504	75,4
91160003		150	ESX-506	75,4
91160004		200	ESX-508	75,4
91160005		250	ESX-5010	75,4
91160006		300	ESX-5012	75,4
91160007	100	50	ESX-1002	132,7
91160008		100	ESX-1004	132,7
91160009		150	ESX-1006	132,7
91160010		200	ESX-1008	132,7
91160011		250	ESX-10010	132,7
91160012		300	ESX-10012	132,7
91160013	150	50	ESX-1502	201
91160014		100	ESX-1504	201
91160015		150	ESX-1506	201
91160016		200	ESX-1508	201
91160017		250	ESX-15010	201
91160018		300	ESX-15012	201
91160019	200	50	ESX-2002	268,8
91160020		150	ESX-2006	268,8
91160021		300	ESX-20012	268,8
91160022	250	50	ESX-2502	363,1
91160023		150	ESX-2506	363,1
91160024		300	ESX-25012	363,1
91160025	300	50	ESX-3002	452,4
91160026		150	ESX-3006	452,4
91160027		300	ESX-30012	452,4
91160028	400	50	ESX-4002	551,5
91160029		150	ESX-4006	551,5
91160030		300	ESX-40012	551,5
91160031	500	50	ESX-5002	730,6
91160032		150	ESX-5006	730,6
91160033		300	ESX-50012	730,6
91160034	600	50	ESX-6002	855,3
91160035		150	ESX-6006	855,3
91160036		300	ESX-60012	855,3
91160037	800	50	ESX-8002	1164,2
91160038		150	ESX-8006	1164,2
91160039		300	ESX-80012	1164,2
91160040	1000	50	ESX-10002	1452,5
91160041		150	ESX-10006	1452,5
91160042		300	ESX-100012	1452,5

ESX SERİSİ / ESX SERIES

- **Yüksek basınç hortumlarını seçiniz.**
Quality pressure hoses.



- **EV-23 ile birlikte kullanılması önerilen yük taşıyıcı manuel kontrol valfi**
Use with EV-23 manually operated check valve for load holding.



- **Aşırı yüklenmeleri önlemek için sistemin çalışma basıncını kontrol etmeye yarayan göstereği seçiniz.**
Pressure gauges available to monitor system pressure.

Yağ Kapasitesi / Oil Capacity	İnmiş Durumda Yükseklik / Collapsed Height	Genişlemiş Durumda Yükseklik/ Extended Height	Dış Çap / Outside Diameter	Piston Mil Çapı / Piston Rod Diam.	Tutucu Cıvata Delikleri / Base Fix Holes			Ağırlık / Weight
					Cıvata Merk. mesafesi/ Bolt Circle	Dış / Thread	Dış Derinliği/ Thread Depth	
					U	V	Z	
cm3	mm	mm	mm	mm	mm	mm	mm	kg
377,2	162	212	129	70	65	M12	22	16
754,2	212	312	129	70	65	M12	22	19
1131,4	262	412	129	70	65	M12	22	23
1508,6	312	512	129	70	65	M12	22	26
1885,8	362	612	129	70	65	M12	22	30
2262,9	412	712	129	70	65	M12	22	34
663,7	179	229	165	95	95	M12	22	28
1327,6	229	329	165	95	95	M12	22	34
1991,3	279	429	165	95	95	M12	22	40
2655,0	329	529	165	95	95	M12	22	45,9
3318,9	379	629	165	95	95	M12	22	51,9
3982,6	429	729	165	95	95	M12	22	57,9
1005,5	196	246	206	115	130	M12	22	47,9
2010,8	246	346	206	115	130	M12	22	56,9
3016,3	296	446	206	115	130	M12	22	65,9
4021,6	346	546	206	115	130	M12	22	74,9
5027,1	396	646	206	115	130	M12	22	84,9
6032,4	446	746	206	115	130	M12	22	93,9
1344,5	212	262	236	135	165	M12	22	67,9
4033,6	312	462	236	135	165	M12	22	92,9
8067,2	462	762	236	135	165	M12	22	128,8
1816,3	235	285	275	165	190	M12	25	103,9
5448,7	335	485	275	165	190	M12	25	138,8
10897,3	485	785	275	165	190	M12	25	191,8
2262,9	312	362	310	195	180	M16	30	176,8
6788,8	412	562	310	195	180	M16	30	222,7
13577,4	562	862	310	195	180	M16	30	292,6
2758,6	374	424	350	215	205	M16	30	269,7
8275,8	474	624	350	215	205	M16	30	329,6
16551,7	624	924	350	215	205	M16	30	420,5
3654,4	419	469	400	250	250	M24	36	400,5
10963,4	519	669	400	250	250	M24	36	479,4
21926,8	669	969	400	250	250	M24	36	598,3
4278,3	429	479	430	265	275	M24	36	473,4
12834,6	529	679	430	265	275	M24	36	564,3
25669,3	679	979	430	265	275	M24	36	700,2
5823,3	484	534	505	320	330	M24	36	740,1
17469,9	584	734	505	320	330	M24	36	867
34940	734	1034	505	320	330	M24	36	1056,7
7262,5	564	614	560	345	375	M24	36	1060,7
21796,3	664	814	560	345	375	M24	36	1211,5
43592,5	814	1114	560	345	375	M24	36	1437,3

EDX SERİSİ / EDX SERIES

ÇİFT TESİRLİ YÜKSEK TONAJLI SİLİNDİRLER DOUBLE ACTING, HIGH TONNAGE CYLINDERS



Soldan sağa doğru modeller /
Shown from left to right
EDX-1006, EDX-1002, EDX-2006

Özellikler

- ASME B-30.1 regülasyonuna uygundur. Yüksek dayanıma sahip çelik alaşım ilave emniyet sistemi sağlar.
- Yanlışlıkla aşırı basınç uygulanmasından kaynaklanacak hasarları önlemek için silindirin çıkışında emniyet valfi.
- Mapa yuvası ve mapa sayesinde taşınması kolaydır.
- EAB 201 yüksek kalite çabuk bağlantı rakortları.
- Çevre dostu boya ile korozyon dayanımı sağlanmıştır.
- Çift tesirli, hidrolik geri dönüşü.

Features

- Complies with ASME B-30.1. High grade steel cylinder is heat treated for additional strength.
- Safety valve in retraction side of cylinder helps to prevent damage in case of accidental over pressurization.
- Easy to carry with threaded hole and ring bolt.
- High flow EAB 201 quick coupler.
- Environmentally friendly painting process provides a durable corrosion resistant finish.
- Double acting, hydraulic return.

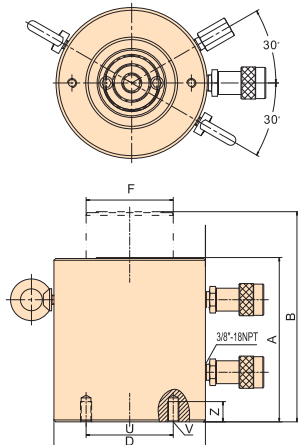

Kod no / Code No	Silindir Kapasitesi @700bar Cylinder Capacity (10.000 PSI)	Strok / Stroke	Model	Maks.Silindir Kapasitesi / Max.Cylinder Capacity		Silindir Etkelilik Alanı / Cylinder Effective Area	
				İleri / Advance	Geri/ Retract	İleri / Advance	Geri / Retract
				ton	ton	² cm	² cm
91170001	50	50	EDX-502	58	25.9	75,4	36,9
91170002		100	EDX-504	58	25.9	75,4	36,9
91170003		150	EDX-506	58	25.9	75,4	36,9
91170004		200	EDX-508	58	25.9	75,4	36,9
91170005		250	EDX-5010	58	25.9	75,4	36,9
91170006		300	EDX-5012	58	25.9	75,4	36,9
91170007	100	50	EDX-1002	102	43.3	132,7	61,9
91170008		100	EDX-1004	102	43.3	132,7	61,9
91170009		150	EDX-1006	102	43.3	132,7	61,9
91170010		200	EDX-1008	102	43.3	132,7	61,9
91170011		250	EDX-10010	102	43.3	132,7	61,9
91170012		300	EDX-10012	102	43.3	132,7	61,9
91170013	150	50	EDX-1502	154	68	201	97,2
91170014		100	EDX-1504	154	68	201	97,2
91170015		150	EDX-1506	154	68	201	97,2
91170016		200	EDX-1508	154	68	201	97,2
91170017		250	EDX-15010	154	68	201	97,2
91170018		300	EDX-15012	154	68	201	97,2
91170019	200	50	EDX-2002	203	88	268,8	125,7
91170020		150	EDX-2006	203	88	268,8	125,7
91170021		300	EDX-20012	203	88	268,8	125,7
91170022	250	50	EDX-2502	279	104.5	363,1	149,2
91170023		150	EDX-2506	279	104.5	363,1	149,2
91170024		300	EDX-25012	279	104.5	363,1	149,2
91170025	300	50	EDX-3002	348	107.6	452,4	153,7
91170026		150	EDX-3006	348	107.6	452,4	153,7
91170027		300	EDX-30012	348	107.6	452,4	153,7
91170028	400	50	EDX-4002	386	132	572	188,4
91170029		150	EDX-4006	386	132	572	188,4
91170030	500	300	EDX-40012	386	132	572	188,4
91170031		50	EDX-5002	563	167.8	730,6	239,7
91170032		150	EDX-5006	563	167.8	730,6	239,7
91170033	600	300	EDX-50012	563	167.8	730,6	239,7
91170034		50	EDX-6002	659	212.6	855,3	303,8
91170035		150	EDX-6006	659	212.6	855,3	303,8
91170036	800	300	EDX-60012	659	212.6	855,3	303,8
91170037		50	EDX-8002	896	251.9	1164,2	359,9
91170038		150	EDX-8006	896	251.9	1164,2	359,9
91170039	1000	300	EDX-80012	896	251.9	1164,2	359,9
91170040		50	EDX-10002	1118	362.2	1452,5	517,4
91170041		150	EDX-10006	1118	362.2	1452,5	517,4
91170042		300	EDX-100012	1118	362.2	1452,5	517,4

EDX SERİSİ / EDX SERIES



Yağ Kapasitesi / Oil Capacity		İnmiş Durumda Yükseklik / Collapsed Height	Genişlemiş Durumda Yükseklik / Extended Height	Dış Çap / Outside Diameter	Piston Mil Çapı / Piston Rod Diam.	Tutucu Cıvata Delikleri / Base Fix Holes			Ağırlık / Weight
İleri / Advance	Geri / Retract					A	B	D	
İleri / Advance	Geri / Retract	A	B	D	F	U	V	Z	kg
cm ³	cm ³	mm	mm	mm	mm	mm	mm	mm	kg
377,2	184,5	162	212	129	70	65	2xM12	22	16
754,2	369,2	212	312	129	70	65	2xM12	22	19
1131,4	553,7	262	412	129	70	65	2xM12	22	23
1508,6	738,3	312	512	129	70	65	2xM12	22	26
1885,8	922,8	362	612	129	70	65	2xM12	22	30
2262,9	1107,5	412	712	129	70	65	2xM12	22	34
663,7	309,6	179	229	165	95	95	2xM12	22	28
1327,6	619,3	229	329	165	95	95	2xM12	22	34
1991,3	928,9	279	429	165	95	95	2xM12	22	40
2655	1238,5	329	529	165	95	95	2xM12	22	45,9
3318,9	1548,2	379	629	165	95	95	2xM12	22	51,9
3982,6	1857,8	429	729	165	95	95	2xM12	22	57,9
1005,5	486,3	196	246	206	115	130	2xM12	22	47,9
2010,8	972,4	246	346	206	115	130	2xM12	22	56,9
3016,3	1458,6	296	446	206	115	130	2xM12	22	65,9
4021,6	1944,7	346	546	206	115	130	2xM12	22	74,9
5027,1	2431	396	646	206	115	130	2xM12	22	84,9
6032,4	2917,2	446	746	206	115	130	2xM12	22	93,9
1344,5	628,8	212	262	236	135	165	3xM12	22	67,9
4033,6	1886,3	312	462	236	135	165	3xM12	22	92,9
8067,2	3772,5	462	762	236	135	165	3xM12	22	128,8
1816,3	746,4	235	285	275	165	190	3xM12	25	103,9
5448,7	2238,9	335	485	275	165	190	3xM12	25	138,8
10897,3	4477,9	485	785	275	165	190	3xM12	25	191,8
2262,9	768,8	312	362	310	195	180	3xM16	30	176,8
6788,8	2306,5	412	562	310	195	180	3xM16	30	222,7
13577,4	4612,8	562	862	310	195	180	3xM16	30	292,6
2860	1055	374	424	350	215	205	3xM16	30	270
7580	3155	474	642	350	215	205	3xM16	30	330
15160	6330	624	924	350	215	205	3xM16	30	421
3654,4	1199	419	469	400	250	250	3xM24	36	400,5
10963,4	3597	519	669	400	250	250	3xM24	36	479,4
21926,8	7193,9	669	969	400	250	250	3xM24	36	598,3
4278,3	1519,6	429	479	430	265	275	3xM24	36	473,4
12834,6	4558,9	529	679	430	265	275	3xM24	36	564,3
25669,3	9117,6	679	979	430	265	275	3xM24	36	700,2
5823,3	1800,2	484	534	505	320	330	3xM24	36	740,1
17469,9	5400,7	584	734	505	320	330	3xM24	36	867
34940	10801,4	734	1034	505	320	330	3xM24	36	1056,7
7265,4	2588,1	564	614	560	345	375	3xM24	36	1060,7
21796,3	7764,1	664	814	560	345	375	3xM24	36	1211,5
43592,5	15528,2	814	1114	560	345	375	3xM24	36	1437,3

ELA-SERİSİ / ELA SERIES

TEK TESİRLİ EMNİYET SOMUNLU ALÜMİNYUM SİLİNDİRLER SINGLE ACTING, ALUMINIUM LOCK NUT



ELA- 1006



Mekanik yük taşıma olanağı sağlayan emniyet somunu.
Load nut feature permits mechanical load holding

Özellikler

- Mekanik yük kaldırmaları için emniyet somunu.
- Hafiflik ve kolay taşıma olanağı.
- EAB 201 yüksek kalite çabuk bağlantı rakorları.
- Strok limitleyici olarak görev yapan taşıma portu.
- Yay geri dönüşlü.
- Taşıma kolu.

Features

- Safety lock nut for mechanical load holding.
- Low weight and good portability.
- High flow EAB 201 quick coupler.
- Overflow port functions as a stroke limiter.
- Spring return.
- Features carrying handle.

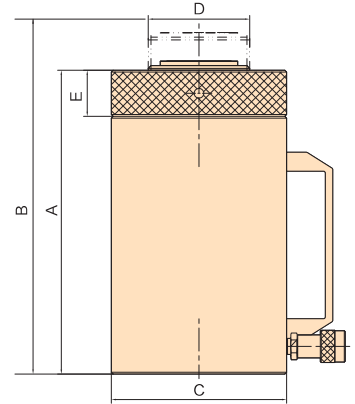

Kod no / Code No	Silindir Kapasitesi @700bar Cylinder Capacity (10.000 PSI)	Strok / Stroke	Model	Maks.Silindir Kapasitesi / Max.Cylinder Capacity	Yağ Kapasitesi / Oil Capacity	Iniş Durumda Yükseklik / Collapsed Height	Genişleşmiş Durumda Yükseklik/ Extended Height	Dış Çap / Outside Diameter	Piston Mil Çapı / Piston Rod Diam.	Somun Kalınlığı / Nut Thickness	Ağırlık / Weight
						A	B				
91138001	50	152.4	ELA-556	70.89	1098	317.5	472	138	Tr 80X4	40	12
91138002	100	152.4	ELA-1006	132.3	2098	340	498	189	Tr 110X6	50	30

ELL SERİSİ / ELL SERIES**YASSI, TEK TESİRLİ EMNİYET SOMUNLU SİLİNDİRLER
PANCAKE LOCK NUT CYLINDERS**

Soldan sağa doğru modeller / Shown from left to right
ELL-602, ELL-1002

Özellikler

- Sınırlı alanlarda kullanım kolaylığı sağlayan minimum silindir yüksekliği.
- Mekanik yük tutmayı sağlayan emniyet somunu.
- Eğimli yük yatakları.
- ASME B-30.1 regülasyonuna uygundur.
- Yüksek dayanıma sahip çelik emniyet sistemi oluşturur.
- Strok limitleyici olarak görev yapan taşma portu.
- EAB 201 yüksek kalite çabuk bağlantı rakorları.
- Çevre dostu boya ile korozyon dayanımı sağlanmıştır.

Features

- Extremely low height for use in confined spaces.
- Safety lock nut for mechanical load holding
- Tilting saddle.
- Complies with ASME B-30.1. High strength steel for durability increased safety.
- Overflow port functions as a stroke limiter.
- High flow EAB 201 quick coupler.
- Environmentally-friendly painting process provides a durable anti-corrosion finish.

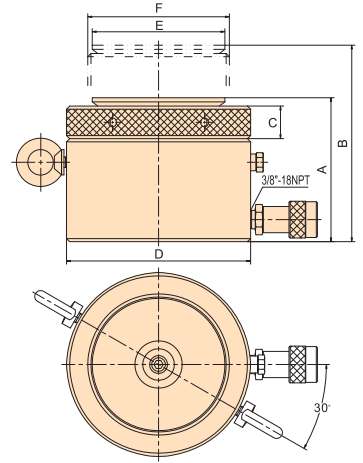

Kod no / Code No	Silindir Kapasitesi @ 700bar Cylinder Capacity (10.000 PSI)	Strok / Stroke	Model	Silindir	Yağ	Inmiş Durumda	Genişlemiş	Emniyet	Dış Çap /	Yatak Kovanı	Piston	Ağırlık / Weight
				Efektif Alanı / Cylinder Effective Area	Kapasitesi / Oil Capacity	Yükseklik / Collapsed Height	Durumda Yükseklik/ Extended Height	Somunu Yüksekliği / Lock Nut High	Çap / Outside Diameter	Çapı / Saddle Diameter	Mil Çapı / Piston Rod Diam.	
				cm ²	cm ³	mm	mm	mm	mm	mm	mm	
91180001	60 (66)	50	ELL-602	86,6	433	125	175	28	140	96	Tr 104x4	14,5
91180002	100 (110)	50	ELL-1002	143,1	716	137	187	31	175	126	Tr 134.5x6	23,5
91180003	160 (176)	45	ELL-1602	227	1022	148	193	40	219	159	Tr 170x6	41,5
91180004	200 (220)	45	ELL-2002	283,5	1276	155	200	43	245	180	Tr 190x6	57
91180005	250 (275)	45	ELL-2502	363,1	1634	159	204	44	275	200	Tr 215x6	74
91180006	400 (440)	45	ELL-4002	551,5	2482	178	223	55	350	250	Tr 265x6	134
91180007	520 (572)	45	ELL-5002	730,6	3288	192	237	62	400	290	Tr 305x6	189

EL SERİSİ / EL SERIES

TEK TESİRLİ EMNİYET SOMUNLU SİLİNDİRLER SINGLE ACTING, LOCK NUT CYLINDERS



Soldan sağa doğru modeller / Shown from left to right
EL-1502 / EL-1506

Özellikler

- Mekanik yük kaldırmaları için emniyet somunu.
- EAB 201 yüksek kalite çabuk bağlantı rakorları.
- Strok limitleyici olarak görev yapan taşma portu.
- Çevre dostu boya ile korozyon dayanımı sağlanmıştır.

Features

- Safety lock nut for mechanical load holding.
- High flow EAB 201 quick coupler.
- Overflow port function as a stroke limiter.
- Environmental-friendly paintings prevent rust and corrosion ability.



1. High strength steel safety nut.
2. Movable piston head is standard accessory.
3. Hardened chrome plated sealed piston prevents wear and corrosion.
4. High strength composite bearings it protects the cylinder walls against off-center loads.
5. Industrial U type gasket prevents oil leaks.
6. Body made of high strength alloy steel It is resistant to abrasion.
7. Dust cap coupling.

Opsiyonel Oynar Piston Başlığı

Kullanılacak Silindir Kapasitesi ton	Oynar Piston Başlığı Modeli
50	ST-100
100	ST-100
150	ST-200
200	ST-200
250	ST-250
300	ST-300
400	ST-400
500	ST-500
600	ST-600
800	ST-800
1000	ST-1000

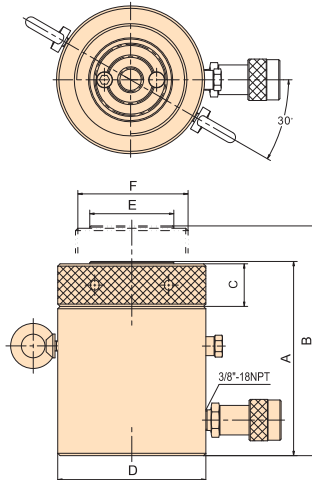

EL SERİSİ / EL SERIES



- Yüksek basınç hortumlarını seçiniz.

Quality pressure hoses



- Aşırı yüklenmeleri önlemek için sistemin çalışma basıncını kontrol etmeye yarayan göstereği seçiniz.

Pressure gauges available to monitor system



- Opsiyonel olarak eğimli ve dişli piston başlıkları mevcuttur.

Optional tilting and threaded saddles available.

Art. No / Code No	Silindir Kapasitesi @700bar Cylinder Capacity (10.000PSI)	Strok / Stroke	Model	Silindir Etketif Alanı Cylinder Effective Area	Yağ Kapasitesi Oil Capacity	İnmiş Durumda Yükseklik Collapsed Height			Genişleşmiş Durumda Yükseklik Extended Height			Emniyet Somunu Yüksekliği Lock Nu Height	Dış Çap Outside Diameter	Yatak Kovani Çapı Saddle Diameter	Piston Mil Çapı Piston Rod Diameter	Ağırlık Weight
						A	B	C	D	E	F					
91190001	50	50	EL-502	70,9	354,6	164	214	36	125	71	Tr 95x4	15				
91190002		100	EL-504	70,9	709,3	214	3134	36	125	71	Tr 95x4	20				
91190003		150	EL-506	70,9	1063,9	264	13	36	125	71	Tr 95x4	25				
91190004		200	EL-508	70,9	1418,6	313	513	36	125	71	Tr 95x4	30				
91190005		250	EL-5010	70,9	1773,2	364	613	36	125	71	Tr 95x4	35				
91190006		300	EL-5012	70,9	2127,9	413	713	36	125	71	Tr 95x4	40				
91190007	100	50	EL-1002	132,7	663,7	187	237	44	44	71	Tr 130x6	30				
91190008		100	EL-1004	132,7	1327,6	237	336	44	44	71	Tr 130x6	47,9				
91190009		150	EL-1006	132,7	1991,3	287	436	44	44	71	Tr 130x6	55,9				
91190010		200	EL-1008	132,7	2655	336	536	44	44	71	Tr 130x6	63,9				
91190011		250	EL-10010	132,7	3318,9	386	636	44	44	71	Tr 130x6	72,9				
91190012		300	EL-10012	132,7	3982,6	436	736	44	44	71	Tr 130x6	82,9				
91190013	150	50	EL-1502	201,1	1006	206	259	44	44	129	Tr160x6	65,9				
91190014		100	EL-1504	201,1	2011,8	259	358	44	44	129	Tr160x6	65,9				
91190015		150	EL-1506	201,1	3017,8	308	458	44	44	129	Tr160x6	77,9				
91190016		200	EL-1508	201,1	4023,6	358	558	44	44	129	Tr160x6	91,9				
91190017		250	EL-15010	201,1	5029,6	408	658	44	44	129	Tr160x6	103,9				
91190018		300	EL-15012	201,1	6035,4	458	758	44	44	129	Tr160x6	116,9				
91190019	200	50	EL-2002	268,7	1344,5	243	292	50	50	129	Tr185x6	82,9				
91190020		150	EL-2006	268,7	4033,6	342	492	50	50	129	Tr185x6	117,9				
91190021		250	EL-20010	268,7	6722,7	442	692	50	50	129	Tr185x6	152,8				
91190022		50	EL-2502	363	1816,3	249	299	56	276	149	Tr 215x6	115,9				
91190023		150	EL-2506	363	5448,7	349	498	56	276	149	Tr 215x6	162,8				
91190024		250	EL-25010	363	9081,2	448	698	56	276	149	Tr 215x6	209,7				
91190025	300	50	EL-3002	452,3	2262,9	294	344	60	309	139	Tr 240x6	172,8				
91190026		150	EL-3006	452,3452,3	6788,8	394	544	60	309	139	Tr 240x6	232,7				
91190027		250	EL-30010	551,4	13314,5	494	744	60	309	139	Tr 240x6	292,6				
91190028		50	EL-4002	551,4	2758,6	335	384	70	350	159	Tr 265x6	250,7				
91190029		150	EL-4006	551,4	8275,8	434	584	70	350	159	Tr 265x6	326,6				
91190030		250	EL-40010	730	13793,1	534	784	70	350	159	Tr 265x6	402,5				
91190031	500	50	EL-5002	730	3652,4	374	424	80	399	179	Tr 305x6	366,6				
91190032		150	EL-5006	730	10957,3	474	624	80	399	179	Tr 305x6	466,4				
91190033		250	EL-50010	854,7	18262,4	574	824	80	399	179	Tr 305x6	567,3				
91190034		50	EL-6002	854,7	4276,1	394	444	85	429	194	Tr 330x6	446,5				
91190035		150	EL-6006	854,7	12828,6	494	644	85	429	194	Tr 330x6	562,3				
91190036		250	EL-60010	1163,3	21381	594	844	85	429	194	Tr 330x6	679,2				
91190037	800	50	EL-8002	1163,3	5820,4	454	504	100	504	224	Tr 385x6	710,1				
91190038		150	EL-8006	1163,3	17460,9	554	704	100	504	224	Tr 385x6	870				
91190039		250	EL-80010	1451,1	29101,6	654	904	100	504	224	Tr 385x6	1029,8				
91190040		50	EL-10002	1451,1	12672,4	494	544	110	559	249	Tr 430x6	949,9				
91190041		150	EL-10006	1451,1	21781,2	594	744	110	559	249	Tr 430x6	1141,6				
91190042		250	EL-100010		36302,1	694	943	110	559	249	Tr 430x6	1333,4				

ESP SERİSİ / ESP SERIES

ÇEKİŞ SİLİNDİRLERİ PULLY CYLINDERS



Soldan sağa doğru modeller / Shown from left to right
ESP-606, ESP-25, ESP-46
ESP-106C, ESP-106E



1. Endüstriyel toz keçesi kir ve pislikler karşı silindiri korur.
2. Yüksek mukavemetli geri dönüş yayı.
3. Yüksek mukavemetli alaşımli çelik gövde.
4. Dahili emniyet valfi milin aşırı açılmasını önler.
5. Yüksek mukavemetli kompozit rulman sayesinde merkezlenmemiş yüklerle karşı silindir duvarlarını korur.
6. Toz kapaklı EAB-201A dişi kaplin.

1. Industrial dust seal protects the cylinder against dirt and impurities.
2. High strength return spring.
3. High strength alloy steel body.
4. Built-in safety valve prevents the spindle from over opening.
5. Thanks to high strength composite bearing It protects the cylinder walls against off-center loads.
6. EAB-201A female coupling with dust cap.

Özellikler

- Yüksek dayanıklı çelik alaşım yapı.
- Aşınma ve paslanma rezistansı için krom piston çubuğu.
- Paslanma ve korozyon dayanıklılığı sağlanmıştır.
- EAB 201 yüksek kalite çabuk bağlantı rakorları.

Features

- High strength alloy steel construction.
- Chromed piston rod for wear and corrosion resistance.
- Baked enamel finish prevent rust and corrosion.
- High flow EAB 201 quick couplers.

Kod no / Code No	Silindir Kapasitesi @700bar Cylinder Capacity (10.000 PSI)	Strok / Stroke mm	Model	Silindir Etketif Alanı Cylinder Effective Area cm ²	Yağ Kapasitesi Oil Capacity cm ³	İnmiş Durumda Yükseklik / Collapsed Height	Genişlemiş Durumda Yükseklik/ Extended Height	Dış Çap / Outside Diameter	Bağlantı Delik Dış Genişliği Link Holes Width
						A	B	D	J
91121001	10 (11)	151	ESP-106C	14,14	214	738	587	85	119
91121002	10 (11)	151	ESP-106L	14,14	214	692	541	85	64
91121003	30 (33)	155	ESP-306	47,71	740	1240	1085	136	114
91121004	50 (55)	152	ESP-606	71,3	1084	871	719	140	130

Kod no / Code No	Silindir Kapasitesi @700bar Cylinder Capacity (10.000 PSI)	Strok / Stroke mm	Model	Silindir Etketif Alanı Cylinder Effective Area cm ²	Yağ Kapasitesi Oil Capacity cm ³	İnmiş Durumda Yükseklik / Collapsed Height	Genişlemiş Durumda Yükseklik/ Extended Height	Dış Çap / Outside Diameter	Piston Mil Çapı / Piston Rod Diam.	Başlık Dış çapı / Top to port
						A	B	D	F	H
91121005	2.5	127	ESP-25	3,9	50	391	264	50	20	45
91121006	5	140	ESP-46	7,5	105	441	301	57	30	42
91121007	10	151	ESP-106	14	214	440	289	85	35	39

ESP SERİSİ / ESP SERIES

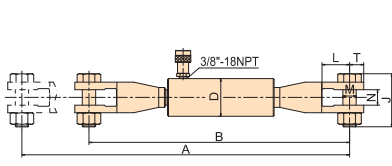

ESP106C

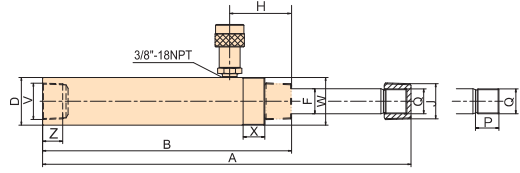

ESP25 ESP46 ESP106

ESP106L

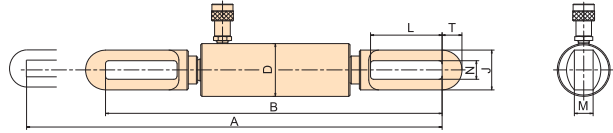

ESP606

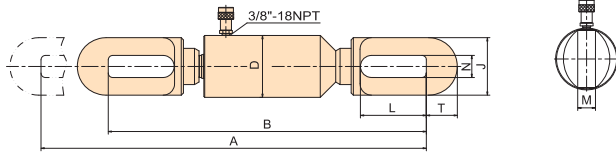

ESP306

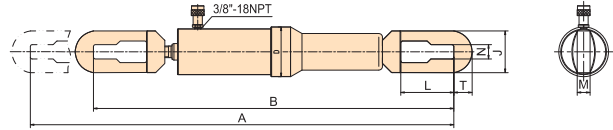

Bağlantı Delik Açılma Uzunluğu Link Holes Opening Length	Bağlantı Civata Çapı Link Bolt Diameter	Bağlantı Delik İç Genişliği Link Holes Width	Bağlantı Delik Ucu Et kalınlığı Link Holes end Width	Ağırlık / Weight	Model
L	M	N	T		
mm	mm	mm	mm	kg	
62	30	35	32	16	ESP-106C
115	22	30	32	13	ESP-106L
145	35	39	50	48	ESP-306
149	40	50	70	54	ESP-606

Yatak Kovanı Çapı Saddle Diameter	Piston Dış Uzunluğu Plunger Thread Length	Piston Dış Uzunluğu Plunger Outside Length	Taban Civata Deliği Base Fix Holes	Sıkma Bileziği Dişi Collar Thread	Sıkma Bileziği Dış Uzunluğu Collar Thread Length	Diş Uzunluğu Thread Length	Ağırlık / Weight	Model
J	P	Q	V	W	X	Z		
in	mm	mm	mm	mm	mm	mm	kg	
3/4"-14	22	11/16"-24UNEF	3/4"-14NPT	1 1/2"-16UN	27	17	1,8	ESP-25
1 1/4"-11 1/2	28	1 3/16"-16UN	1 1/4"-11 1/2NPT	2 1/4"-14UN	26	24	4,5	ESP-46
-	20	M30*2	M30X2	M85X2	25	27	9,5	ESP-106

HİDROLİK EL POMPASI SEÇİM TABLOSU

HYDRAULIC HAND PUMP SELECTION CHART/

MODEL	Kademe Stage	Akış / Flow (in ³)	Kapasite / Capacity (ton)															
			5	10	15	25	30	50	75	100	150	200	250	300	400	500		
			1" Kaldırmak için gerekli silindirik stroku / Required strokes for cylinder to lift 1 inch															
EPA-10521	1. Kademe / 1st. Stage	0.22	5	10	15													
	2. Kademe / 2st. Stage	0.05	19	42	58													
EPA-10921A	1. Kademe / 1st. Stage	2.038	1	2	2	3												
	2. Kademe / 2st. Stage	0.201	6	12	16	26												
EPA-10922A	1. Kademe / 1st. Stage	2.038	1	2	2	3												
	2. Kademe / 2st. Stage	0.201	6	12	16	26												
EPA-12321A	1. Kademe / 1st. Stage	2.038	1	2	2	3	4	6	8									
	2. Kademe / 2st. Stage	0.201	6	12	16	26	31	55	81									
EPA-12322A	1. Kademe / 1st. Stage	1.59	1	2	2	3	3	6	8									
	2. Kademe / 2st. Stage	0.18	6	12	16	26	34	55	81									
EPA-14521	1. Kademe / 1st. Stage	1.59	1	1	2	3	4	8	10	13	19	26						
	2. Kademe / 2st. Stage	0.18	6	13	18	29	38	69	90	114	174	229						
EPA-14522	1. Kademe / 1st. Stage	1.59	1	1	2	3	4	8	10	13	19	26						
	2. Kademe / 2st. Stage	0.18	6	13	18	29	38	69	90	114	174	229						
EPA-17522	1. Kademe / 1st. Stage	7.63	1	1	1	1	1	2	2	3	4	5	7					
	2. Kademe / 2st. Stage	0.35	3	7	9	15	19	35	45	58	88	116	158					
EPA-17521	1. Kademe / 1st. Stage	7.63	1	1	1	1	1	2	2	3	4	5	7					
	2. Kademe / 2st. Stage	0.35	3	7	9	15	19	35	45	58	88	116	158					

HAVALI HİDROLİK EL POMPASI SEÇİM TABLOSU

AIR HYDRAULIC HAND PUMP SELECTION CHART

MODEL	Tek Kademe Single Stage	Akış / Flow (in ³)	Kapasite / Capacity (ton)															
			5	10	15	25	30	50	75	100	150	200	250	300	400	500		
			1" Kaldırmak için gerekli zaman (sn) / Required time (seconds) for cylinder to lift 1 inch															
EPC-001	Alçak Basınç / Low Pressure	0.81	1.30	2.90	3.90	6.40	8.30	15.00	19.50	25.60								
	Yüksek Basınç / High Pressure	0.12	8.70	19.00	26.30	42.50	55.00	100.00	130.00	166.00								
EPC-002	Alçak Basınç / Low Pressure	0.81	1.30	2.90	3.90	6.40	8.30	15.00	19.50									
	Yüksek Basınç / High Pressure	0.12	8.70	19.00	26.30	42.50	55.00	100.00	130.00									
EPC-003	Alçak Basınç / Low Pressure	0.81	1.30	2.90	3.90	6.40	8.30	15.00	19.50	25.60								
	Yüksek Basınç / High Pressure	0.12	8.70	19.00	26.30	42.50	55.00	100.00	130.00	166.00								
EPC-004	Alçak Basınç / Low Pressure	0.81	1.30	2.90	3.90	6.40	8.30	15.00	19.50	25.60	38.00							
	Yüksek Basınç / High Pressure	0.12	8.70	19.00	26.30	42.50	55.00	100.00	130.00	166.00	252.50							
EPC-008	Alçak Basınç / Low Pressure	0.81	1.30	2.90	3.90	6.40	8.30	15.00	19.50									
	Yüksek Basınç / High Pressure	0.12	8.70	19.00	26.30	42.50	55.00	100.00	130.00									
EPC-009	Alçak Basınç / Low Pressure	0.81	1.30	2.90	3.90	6.40	8.30	15.00	19.50	25.60	38.00							
	Yüksek Basınç / High Pressure	0.12	8.70	19.00	26.30	42.50	55.00	100.00	130.00	166.00	252.50							
EPC-010	Alçak Basınç / Low Pressure	0.81	1.30	2.90	3.90	6.40	8.30	15.00	19.50									
	Yüksek Basınç / High Pressure	0.12	8.70	19.00	26.30	42.50	55.00	100.00	130.00									

HİDROLİK ELEKTRİK POMPASI SEÇİM TABLOSU

HYDRAULIC ELECTRIC PUMP SELECTION CHART

MODEL	Tek Kademe Single Stage	Akış / Flow (in ³)	Kapasite / Capacity (ton)															
			5	10	15	25	30	50	75	100	150	200	250	300	400	500		
			1" Kaldırmak için gerekli zaman (sn) / Required time (seconds) for cylinder to lift 1 inch															
EPB-3B+	1. Kademe / 1st. Stage	4.00	0.3	0.6	0.8	1.3	1.7	2.8	4.0	5.1								
	2. Kademe / 2st. Stage	0.27	4.1	8.4	12.2	19.3	25.5	41.2	60.3	76.8								
EPB-6B+	1. Kademe / 1st. Stage	10.17	0.1	0.2	0.3	0.5	0.7	1.1	1.6	2.0	3.0	4.1						
	2. Kademe / 2st. Stage	0.65	1.7	3.5	5.0	7.9	10.5	16.9	24.8	31.5	47.5	63.4						
EPB-10B+	1. Kademe / 1st. Stage	10.17	0.1	0.2	0.3	0.5	0.7	1.1	1.6	2.0	3.0	4.1	5.5					
	2. Kademe / 2st. Stage	1.00	1.1	2.3	3.3	5.2	6.8	11.0	16.1	20.5	30.9	41.2	56.2					
EPB-20B+	1. Kademe / 1st. Stage	10.17	0.1	0.2	0.3	0.5	0.7	1.1	1.6	2.0	3.0	4.1	5.5	7.0	8.7	11.1		
	2. Kademe / 2st. Stage	1.67	0.7	1.3	2.0	3.1	4.1	6.6	9.6	12.3	18.5	24.7	33.7	42.3	53.1	67.8		

 Tavsiye edilen uygulama / Recommended application

 Seçici kullanım / Selective use

 Tavsiye edilmez / Not recommended

EPA SERİSİ / EPA SERIES

EL POMPALARI / HAND PUMPS

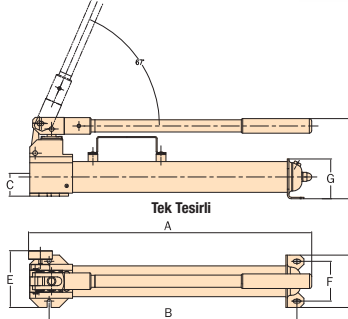
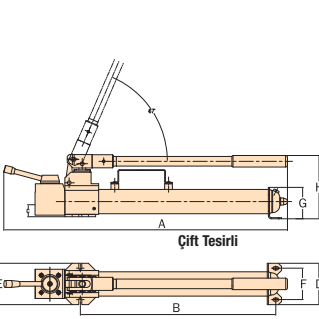

Özellikler

- Ağır çevresel şartlarda kullanıma uygun yüksek dayanıma sahip çelik alaşım yapı.
- Taşınması kolay, yer kaplamayan dizayn.
- Kullanıcı dostu tasarım.
- Yapı üzerinde mevcut emniyet valfi.
- Silindir ve diğer ekipmanlara güç sağlayıcıdır.

Features

- High strength steel alloy, engineered in use for extreme environment.
- Compact easy to carry.
- User friendly design.
- Built-in safety valve.
- Used for various cylinders and tools.

Kullanılan Silindir Tipi / Used with cylinder	Kod no / Code No	Model	Hız Speed	Kullanılabilir Yağ Kapasitesi Usable Oil Capacity	Basınç Oranları Pressure Rating		Yağ Çıktısı / Strok Oil Output Per Stroke		Kol Kuvveti Handle force	Diş Yağ Çıktısı Output Oil Thread	Ağırlık / Weight
					Aşama 1 Stage 1	Aşama 2 Stage 2	Aşama 1 Stage 1	Aşama 2 Stage 2			
					cm3	psi	cm3	cm3			
Tek Tesirli / Single Acting	91123001	EPA 10521*	Çift / Double	330	200	10,000	7,9	0,8	35	3/8 - 18NPT	2.2
	91123003	EPA 10921A	Çift / Double	900	360	10,000	33,5	3,3	49	3/8 - 18NPT	7.3
	91123005	EPA 12321A	Çift / Double	2300	360	10,000	33,5	3,3	49	3/8 - 18NPT	10,1
	91123011	EPA 10921C	Çift / Double	330	360	10,000	33,5	3,3	49	3/8 - 18NPT	13
Çift Tesirli / Double Acting	91123007	EPA 10922A	Çift / Double	900	360	10,000	33,5	3,3	49	3/8 - 18NPT	8,8
	91123009	EPA 12322A	Çift / Double	2300	360	10,000	33,5	3,3	49	3/8 - 18NPT	11.6

*EPA 10521: Alüminyum el pompası üzerinde vana blogu ve alüminyum haznesi bulunur.

* EPA 10521: There is a valve block and aluminum chamber on the aluminum hand pump.

Kod no / Code No	Model	A	B	C	D	E	F	G	H
		mm	mm	mm	mm	mm	mm	mm	mm
91123001	EPA 10521	374	290	/	80	109	67	/	142
91123003	EPA 10921A	581	505	47	108	130	82	82	165
91123005	EPA 12321A	738	507	47	125	137	/	82	161
91123007	EPA 10922A	581	505	29	108	107	82	82	165
91123009	EPA 12322A	738	507	29	125	107	/	82	161115
91123011	EPA 10921C	525	488	47	108	130	90	80	8

EPA SERİSİ / EPA SERIES

EL POMPASI / HAND PUMPS



Özellikler

- Ağır çevresel şartlarda kullanıma uygun yüksek dayanıma sahip çelik alaşım yapı.
- Kullanıcı dostu tasarım.
- Yapı üzerinde mevcut emniyet valfi.

Features

- High strength steel alloy, engineered in use for extreme environment.
- User friendly design.
- Built-in safety valve.

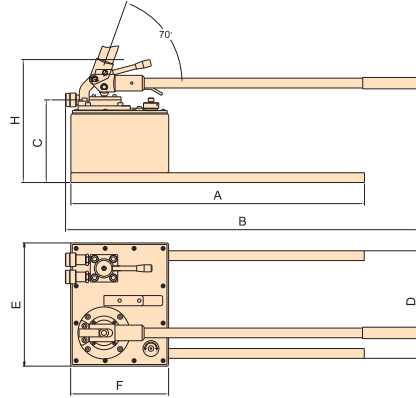

Kod no / Code No	Kullanılan Silindir / Used With Cylinder	Model	Hız Speed	Kullanılabilir Yağ Hacmi Usable Oil Volume	Basınç Oranları Pressure Rating		Yağ Çıktısı / Strok Oil Output Per Stroke		Kol Kuvveti Handle force	Dış Yağ Çıktısı Output Oil Thread	Ağırlık / Weight
					Aşama 1 1 Stage	Aşama 2 2 Stage	Aşama 1 1 Stage	Aşama 2 2 Stage			
					cm3	psi	psi	cm3			
91123012	Tek Tesirli / Single Acting	EPA - 14521	Çift/Double	4500	260	10.000	26.1	3	50.8	3/8 - 18NPT	22.5
91123014		EPA - 17521	Çift/Double	7500	260	10.000	124.6	5,7	50.8	3/8 - 18NPT	30
91123013		EPA - 14522	Çift/Double	4500	260	10.000	26.1	3	50.8	3/8 - 18NPT	22.5
91123015	Çift Tesirli / Double Acting	EPA - 17522	Çift/Double	7500	260	10.000	124.6	5,7	50.8	3/8 - 18NPT	30

Model	A	B	C	D	E	F	H
	mm	mm	mm	mm	mm	mm	mm
EPA-10922A (14521)	579	607	163	274	315	249	267
EPA-12322A (17521)	800	904	211	274	315	249	315
EPA - 14522	579	607	163	274	315	249	267
EPA - 17522	800	904	211	274	315	249	315

EPA SERİSİ / EPA SERIES

ULTRA YÜKSEK BASINÇ EL POMPASI

ULTRA HIGH PRESSURE HAND PUMP

EPA-21621

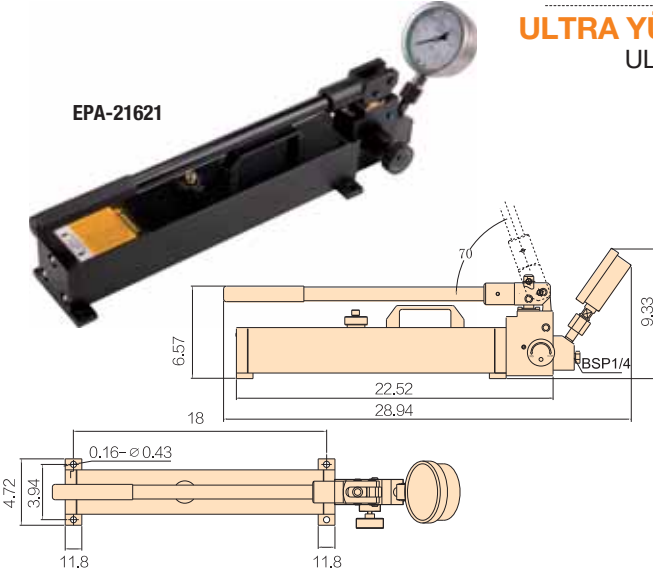

Özellikler

- Ağır çevresel şartlarda kullanıma elverişli yüksek dayanıma sahip tasarım.
- Çift hızlı pompa.
- Aşırı yük koruması için dahili valf.
- Ergonomik kol tasarımı çalışma esnasında minimum efor sarfedilmesini sağlar.

Features

- Convenient high strength design, engineered for use in extreme environments.
- Dual speed pump.
- Built-in safety valve for overload protection
- Unique handle designed require less effort, saving you time and energy.

Ultra Yüksek Basınçlı Pompa / Ultra High Pressure Hand Pump

Kod no / Code No	Kullanılan Silindir / Used With Cylinder	Model	Hız Speed	Kullanılabilir Yağ Hacmi Usable Oil Volume	Basınç Oranları Pressure Rating		Yağ Çıktısı / Strok Oil Output Per Stroke		Kol Kuvveti Handle force	Dış Yağ Çıktısı Output Oil Thread	Ağırlık / Weight
					Aşama 1 1. Stage	Aşama 2 2. Stage	Aşama 1 1. Stage	Aşama 2 2. Stage			
					cm ³	psi	psi	cm ³			
91123016	Tek Tesirli Single Acting	EPA - 21621	Çift/Double	1600	290	20.000	26,1	0,8	20	1/4 BSP	9.5

Ultra Yüksek Basınçlı Hortum / Ultra High Pressure Hydraulic Hoses

Kod no / Code No	Hortum Malzemesi Hose Material	Model	İç Çap Internal Dia.	Çalışma Basıncı Work Pressure	Patlama Basıncı Burst Pressure	Diş Tread	Uzunluk Length
			in	psi	psi		m
91133011	Termo Plastik Thermo Plastic	EH-7103	1/8"	20.000	65.000	1/4 BSP	0.9
91133008	Termo Plastik Thermo Plastic	EH-7106	1/8"	20.000	65.000	1/4 BSP	1.8
91133009	Termo Plastik Thermo Plastic	EH-7110	1/8"	20.000	65.000	1/4 BSP	3
91133010	Termo Plastik Thermo Plastic	EH-7120	1/8"	20.000	65.000	1/4 BSP	6



Ultra Yüksek Basınçlı Kaplin / Ultra High Pressure Hydraulic Couplers

Kod no / Code No	Tip / Type	Model	Erkek Kaplin Male Couplers	Dişi Kaplin Female Couplers	Maksimum Basınç Max. Pressure	Diş Tread
91132004 - Dişi 91132008 - Erkek	Ultra Yüksek Akış	EAB - 204	EAB 204B	EAB 204A	20.000	1/4 BSP



EPB SERİSİ / EPB SERIES

ELEKTRİKLİ POMPA / ELECTRIC PUMPS



EPB -171A (3B5P5A)



EPB-175A (3B1P5A)

Yağ Hazne Kapasitesi / Reservoir Capacity

2.0 / 5.0 / 10.0 Litre

Akış / Flow at Rated Pressure

0.3 / 0.6 l/dk

Motor

0.75 / 1.0 hp

Özellikler

- Pek çok sektörel uygulamalar için kullanılır.
- Yüksek akış oranı 0.3 lt/ dk ve 0.6 lt/ dk ulaşır.
- 3m 24V uzaktan kumanda veya selenoid kumanda.
- 0.75 hp ve 1.0 hp motor
- Tam yük altında çalışır.
- Taşıma kolu ile yüksek dayanıma sahip gövde.

EPB-3B Serisi

Art.No Code No	Model	Kullanıldığı Silindir Used With Cylinder	Tanım / Description	Çıkış Akış Oranı Output Flow Rate (lt/ dk)	
				1. Kademe 1. Stage	2. Kademe 2. Stage
91124001	EPB 171A (3B1P5E)	Tek Tesirli Single Acting	5 lt yağ kapasitesi, 2W/ 3P, manuel vana, kumanda swici, 380 W 1.3 Gallon usable oil reservoir, 2W/3P manual valve, pendant switch, 380W	3.9	0.3
91124012	EPB 1710A (3B10P2E)	Dump	5 lt yağ kapasitesi, 4W/ 3P dump vanalı. Kaldırma amaçlı değil, kırma, delme, pres işlemleri için uygundur. / 1.3 Gallon usable oil reservoir, 4W/3P withdump valve. Suited for crimping, punching, pressing, not for lifting.	3.9	0.3
91124005	EPB 175A (3B5P5E)	Çift Tesirli Double Acting	5 lt yağ kapasitesi, 2W/ 2P manuel vana, kumanda swici, 380 W 1.3Gallon usable oil reservoir, 2W/2P manual valve, pendant switch, 380W	3.9	0.3

Valf Valve	Valf Tipi Valve Type	Valf Fonksiyonu Valve Function	Kontrol Anahtarı Control Type	Motor	Kullanılabilir Yağ Kapasitesi Usable Oil Capacity		Ağırlık Weight
					lt	cm ³	
EV 42H2	2W, 2P	İleri- Geri ** Advance-Return	Kablolu Kumanda (3m) Cable Control (3m)	380 V, 50Hz	5	4930	25.4
EV 62H3	2W, 2P	İleri- Geri ** Advance-Return	Kablolu Kumanda (3m) Cable Control (3m)	380 V, 50Hz	5	4930	25.4
EV 43M4	Auto/ Dump 4W, 3P	İleri- Tutma-Geri Advance-Hold- Return	Kablolu Kumanda (3m) Cable Control (3m)	380 V, 50Hz	5	4930	25.4

EPB-6B Serisi

Art.No Code No	Model	Kullanıldığı Silindir Used With Cylinder	Tanım / Description	Çıkış Akış Oranı Output Flow Rate (lt/ dk)	
				1. Kademe 1st. Stage	1. Kademe 1st. Stage
91124013	EPB 508A (6B8P10E)	Tek Tesirli Single Acting	8 lt yağ kapasitesi, 3W/ 3P selenoid vana, kumanda swici, 380 W 2.6 Gallon usable oil reservoir, 4W/2P selenoid valve, pendant switch, 380W	9.8	0.6
91124014	EPB 502SA (6B2D10E)	Tek Tesirli Single Acting	8 lt yağ kapasitesi, 2W/ 2P manuel vana, kumanda swici, 380 W 2.6 Gallon usable oil reservoir, 3W/3P manual valve, pendant switch, 380W	9.8	0.6
91124015	EPB 505A (6B5P10E)	Çift Tesirli Double Acting	8 lt yağ kapasitesi, 4W/ 3P manuel vana, kumanda swici, 380 W 2.6 Gallon usable oil reservoir, 4W/3P manual valve, pendant switch, 380W	9.8	0.6
91124016	EPB 504SA (6B4D10E)	Çift Tesirli Double Acting	8 lt yağ kapasitesi, 4W/ 2P selenoid vana, kumanda swici, 380 W 2.6 Gallon usable oil reservoir, 2W/2P selenoid valve, pendant switch, 380W	9.8	0.6

Valf Valve	Valf Tipi Valve Type	Valf Fonksiyonu Valve Function	Kontrol Anahtarı Control Type	Motor	Kullanılabilir Yağ Kapasitesi Usable Oil Capacity		Ağırlık Weight
					lt	cm ³	
EV 43M3	3W, 3P	İleri- Tutma-Geri Advance-Hold- Return	Kablolu Kumanda (3m) Cable Control (3m)	380 V, 50Hz	10	9858	34
EV 52H2	2W, 2P	İleri- Geri ** Advance-Return	Kablolu Kumanda (3m) Cable Control (3m)	380 V, 50Hz	10	9858	34
EV 43M4	4W, 3P	İleri- Tutma-Geri Advance-Hold- Return	Kablolu Kumanda (3m) Cable Control (3m)	380 V, 50Hz	10	9858	34
EV 52H4	4W, 2P	İleri- Geri ** Advance-Return	Kablolu Kumanda (3m) Cable Control (3m)	380 V, 50Hz	10	9858	34

**Motor kapalı konumda iken "İleri" pozisyonu basınç tutar.

** "Forward" position keeps pressure while the engine is turned off.

EPB SERİSİ / EPB SERIES

ELEKTRİKLİ POMPA / ELECTRIC PUMPS

Yağ Hazne Kapasitesi / Reservoir Capacity

10 / 20 Litre

Akış / Flow at Rated Pressure

0.96 / 1.92 l/dk

Motor

2.0/ 3.0 hp



EPB- 10B4D10A

EPB- 10B5P10A

Features

- Covers most applications in the industry.
- High flow rate reaches 0.3 lt/ min and 0.6 lt/ min
- 3m 24 V remote control or solenoid control for operator safety.
- 0.75 hp and 1.0 hp motor.
- Starts under full load.
- High strengt frame with handle for maximum portability.

EPB-10B Serisi

Art.No Code No	Model	Kullanıldığı Silindir Used With Cylinder	Tanım / Description	Çıkış Akış Oranı Output Flow Rate (lt/ dk)	
				1. Kademe 1. Stage	2. Kademe 2. Stage
91124017	EPB 10B8P10E	Tek Tesirli Single Acting	10 lt yağ kapasitesi, 3W/ 3P solenoid vana, kumanda swici, 380 W 2.6 Gallon usable oil reservoir, 4W/2P solenoid valve, pendant switch, 380W	9.8	0.96
91124018	EPB 10B2D10E	Tek Tesirli Single Acting	10 lt yağ kapasitesi, 2W/ 2P manuel vana, kumanda swici, 380 W 2.6 Gallon usable oil reservoir, 3W/3P manuel valve, pendant switch, 380W	9.8	0.96
91124007	EPB 10B5P10E	Çift Tesirli Double Acting	10 lt yağ kapasitesi, 4W/ 3P manuel vana, kumanda swici, 380 W 2.6 Gallon usable oil reservoir, 4W/3P manuel valve, pendant switch, 380W	9.8	0.96
91124008	EPB 10B4D10E	Çift Tesirli Double Acting	10 lt yağ kapasitesi, 4W/ 2P solenoid vana, kumanda swici, 380 W 2.6 Gallon usable oil reservoir, 2W/2P solenoid valve, pendant switch 380W	9.8	0.96

Valf	Valf Tipi	Valf Fonksiyonu	Kontrol Anahtarı	Motor	Kullanılabilir Yağ Kapasitesi		Ağırlık
					lt	cm ³	
EV 43M3	3W, 3P	İleri- Geri ** Advance-Return	Kablolu Kumanda (3m) Cable Control (3m)	380 V, 50Hz	10	9858	45
EV 52H2	2W, 2P	İleri- Geri ** Advance-Return	Kablolu Kumanda (3m) Cable Control (3m)	380 V, 50Hz	10	9858	45
EV 43M4	4W, 3P	İleri- Tutma-Geri Advance-Hold- Return	Kablolu Kumanda (3m) Cable Control (3m)	380 V, 50Hz	10	9858	45
EV 52H4	4W, 2P	İleri- Geri ** Advance-Return	Kablolu Kumanda (3m) Cable Control (3m)	380 V, 50Hz	10	9858	45

EPB-20 Serisi

Art.No Code No	Model	Kullanıldığı Silindir Used With Cylinder	Tanım / Description	Çıkış Akış Oranı Output Flow Rate (lt/ dk)	
				1. Kademe 1. Stage	2. Kademe 2. Stage
91124019	EPB 1008 (20B8M20E)	Tek Tesirli Single Acting	20 lt yağ kapasitesi, 3W/ 3P manuel vana, kumanda swici, 380 W	9.8	1.92
91124020	EPB 1005C (20M5M20E)	Çift Tesirli Double Acting	20 lt yağ kapasitesi, 2W/ 2P solenoid vana, kumanda swici, 380 W	9.8	1.92

Valf Valve	Valf Tipi Valve Type	Valf Fonksiyonu Valve Function	Kontrol Anahtarı Control Type	Motor	Kullanılabilir Yağ Kapasitesi Usable Oil Capacity		Ağırlık Weight
					lt	cm ³	
EV 43M3	3W, 3P	İleri- Tutma-Geri Advance-Hold- Return	Manuel Kontrol (3m) Manuel Control (3m)	380 V, 50Hz	20	20000	55
EV 43M4	4W, 3P	İleri- Tutma-Geri Advance-Hold- Return	Manuel Kontrol (3m) Manuel Control (3m)	380 V, 50Hz	20	20000	55

**Motor kapalı konumda iken "İleri" pozisyonu basınç tutar.

** "Forward" position keeps pressure while the engine is turned off.

EPB SERİSİ / EPB SERIES

YÜKSEK KAPASİTELİ YAĞ TANKLARI / LARGE OIL RESERVOIR KITS

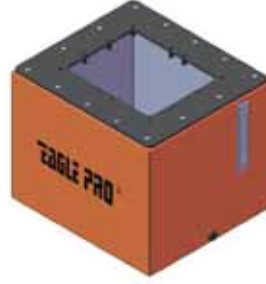
**EPB-5020LRK****EPB-5040LRK**

Art.No Code No:	Hazne Modeli Tank Model	Elektrik Pompa Modeli Elektrik Pump Model	Tanım / Description	Malzeme Material
91142001	EPB 1708LRK	EPB 17 SERİSİ	EPB - 17 Serisine uygun 8 lt yağ kapasiteli tank 2.1 Gallon/8L Reservoir kits for EPB-17 Seris	Alüminyum Aluminium
91142002	EPB 5020LRK	EPB 50 SERİSİ	EPB - 50 Serisine uygun 20 lt yağ kapasiteli tank 5.3 Gallon/20L Reservoir kits for EPB-50 Seris	Alüminyum Aluminium
91142003	EPB 5040LRK	EPB 50 SERİSİ	EPB - 50 Serisine uygun 40 lt yağ kapasiteli tank 10 Gallon/40L Reservoir kits for EPB-50 Seris	Çelik Steel
91142004	EPB 10040LRK	EPB 100 SERİSİ	EPB - 100 Serisine uygun 40 lt yağ kapasiteli tank 10 Gallon/40L Reservoir kits for EPB-100 Seris	Çelik Steel
91142005	EPB 10080LRK	EPB 100 SERİSİ	EPB - 100 Serisine uygun 80 lt yağ kapasiteli tank 20 Gallon/80L Reservoir kits for EPB-100 Seris	Çelik Steel

ELEKTRİK POMPASI KORUYUCU KAFES / ROLL CAGES

**EPB-5040RC****EPB-5020RC**

Art.No Code No:	Hazne Modeli Tank Model	Elektrik Pompa Modeli Elektrik Pump Model	Tanım / Description	Malzeme Material
91143001	EPB 175 RC	EPB 17 SERİSİ	EPB - 17 Serisi tanklı pompa için kafes 5 lt 1.3 Gallon/5L Reservoir kits for EPB-17 Seris	Çelik Steel
91143002	EPB 178 RC	EPB 17 SERİSİ	EPB - 17 Serisi tanklı pompa için kafes 5 lt 1.3 Gallon/5L Reservoir kits for EPB-17 Seris	Çelik Steel
91143003	EPB 508 RC	EPB 50 SERİSİ	EPB - 50 Serisi tanklı pompa için kafes 8 lt 2.1 Gallon/8L Reservoir kits for EPB-50 Seris	Çelik Steel
91143004	EPB 5020 RC	EPB 50 SERİSİ	EPB - 50 Serisi tanklı pompa için kafes 20 lt 5.3 Gallon/20L Reservoir kits for EPB-50 Seris	Çelik Steel
91143005	EPB 5040 RC	EPB 50 SERİSİ	EPB - 50 Serisi tanklı pompa için kafes 40 lt 10 Gallon/40L Reservoir kits for EPB-50 Seris	Çelik Steel
91143006	EPB 10020 RC	EPB 100 SERİSİ	EPB - 100 Serisi tanklı pompa için kafes 20 lt 5.3 Gallon/20L Reservoir kits for EPB-100 Seris	Çelik Steel
91143007	EPB 10040 RC	EPB 100 SERİSİ	EPB - 100 Serisi tanklı pompa için kafes 40 lt 10 Gallon/40L Reservoir kits for EPB-100 Seris	Çelik Steel
91143008	EPB 10080 RC	EPB 100 SERİSİ	EPB - 100 Serisi tanklı pompa için kafes 80 lt 20 Gallon/80L Reservoir kits for EPB-100 Seris	Çelik Steel

EPC SERİSİ / EPC SERIES

HAVALI TAHRİKLİ POMPALAR / AIR HYDRAULIC PUMPS

Özellikler

- Farklı hidrolik silindirler, presler ve diğer hidrolik araçlarla kullanım imkanı.
- Çalışma hava basıncı 0.6-1.0 MPa.
- 10000 psi ye kadar çalışma basıncı.
- Giriş portu dişi 1/4-18 NPT ve çıkış portu dişi 3/8-18 NPT".
- Aşırı yüklenmeyi önleyici dahili yük seviyelendirici.
- Hava motorunun sessiz pompalamasını sağlayan hava egzoz susturucusu.
- Dış kirlilikle oluşabilecek hasar riskini azaltan hava ve yağ filtresi.
- Çeşitli ebatlarda, plastik, alüminyum ve çelik malzemeden yağ tankı seçeneği.

Features

- Can be used with a variety of hydraulic cylinders, presses or other hydraulic tools.
- Operating air pressure between 0.6 -1.0 MPa.
- Provides up to 10000 PSI of hydraulic pressure.
- Input port thread 1/4-18 NPT and output 3/8-18 NPT.
- Internal load limiting device avoids overload.
- Air exhaust muffler for quiet operation.
- Pumps feature both air and oil filters to reduce risk of damage from environmental contaminates.
- Various capacities available with plastic, aluminum or steel housings.



- Havlandırma valfi ile daha iyi kullanım ve koruma.

Knob style vent valve provides better operation and protection



EPC - 010

EPC - 001

EPC - 002

EPC - 009

EPC - 004

EPC - 003

EPC - 008

EPC - 200

Kod no Code No	Model	Basınç Oran Pressure Rating	Hava Kaynak Basıncı Air Source Pressure	Efektif Yağ Kapasitesi Effective Oil Capacity	Akış / Flow/ (cm ³ / min) (cm ³ / dk)		Boyutlar Dimensions (mm)			Yağ Tankı Metaryali Oil Tank Material	Çalıştırma şekli Operational Manner	Ağırlık Weight
		psi	psi	cm ³	Yüksüz No Load	Yükli Load	L	W	H		kg	
91125001	EPC 001	10000	90-145	2294	49.5	7.6	312	170	191	Plastik Engineering Plastic	Ayak Pedallı Foot Pedal	49
91125002	EPC 002	10000	90-145	1606	49.5	7.6	262	135	185	Alüminyum Alaşım/ Alloy Aluminum	Ayak Pedallı Foot Pedal	12
91125003	EPC 003	10000	90-145	4506	49.5	7.6	317	178	191	Çelik / Steel	Ayak Pedallı Foot Pedal	8.6
91125004	EPC 004	10000	90-145	7243	49.5	7.6	279	223	254	Çelik / Steel	Ayak Pedallı Foot Pedal	12.6
91125008	EPC 008	10000	90-145	1606	49.5	7.6	262	135	185	Alüminyum Alaşım Alloy Aluminum	Uzaktan Kumanda Remote Control	16.3
91125009	EPC 009	10000	90-145	7243	49.5	7.6	262	135	185	Çelik / Steel	Uzaktan Kumanda Remote Control	11.3
91125010	EPC 010	10000	90-145	1606	49.5	7.6	262	135	185	Plastik Engineering Plastic	Ayak Pedallı Foot Pedal	8.6

EH SERİSİ / EH SERIES

YÜKSEK BASINÇ HORTUMLARI HIGH PRESSURE HOSES







Art.No Code No	Model	Hortum Malzemesi Hose Material	İç Çap Internal Dia.	Çalışma Basıncı Working Pressure	Patlama Basıncı Burst Pressure	Diş Thread	Uzunluk / Length	
							(ft)	(m)
91133011	EH 7103	Termo P.	1/8"	20.000 psi	65.000 psi	1/4 BSP	3	0,9
91133008	EH 7106	Termo P.	1/8"	20.000 psi	65.000 psi	1/4 BSP	6	1,8
91133009	EH 7110	Termo P.	1/8"	20.000 psi	65.000 psi	1/4 BSP	10	3
91133010	EH 7120	Termo P.	1/8"	20.000 psi	65.000 psi	1/4 BSP	20	6
91133001	EH 7203	Termo P.	1/4"	10.000 psi	40.000 psi	3/8 NPT	3	0,9
91133002	EH 7206	Termo P.	1/4"	10.000 psi	40.000 psi	3/8 NPT	6	1,8
91133003	EH 7210	Termo P.	1/4"	10.000 psi	40.000 psi	3/8 NPT	10	3
91133004	EH 7220	Termo P.	1/4"	10.000 psi	40.000 psi	3/8 NPT	20	6
91133025	EH 8203	Lastik	1/4"	10.000 psi	20.000 psi	3/8 NPT	3	0,9
91133026	EH 8206	Lastik	1/4"	10.000 psi	20.000 psi	3/8 NPT	6	1,8
91133027	EH 8206T	Lastik	1/4"	10.000 psi	20.000 psi	1/4 NPT	6	1,8
91133028	EH 8210	Lastik	1/4"	10.000 psi	20.000 psi	3/8 NPT	10	3
91133029	EH 8220	Lastik	1/4"	10.000 psi	20.000 psi	3/8 NPT	20	6
91133030	EH 8303	Lastik	3/8"	10.000 psi	20.000 psi	3/8 NPT	3	0,9
91133031	EH 8306	Lastik	3/8"	10.000 psi	20.000 psi	3/8 NPT	6	1,8
91133032	EH 8310	Lastik	3/8"	10.000 psi	20.000 psi	3/8 NPT	10	3
91133033	EH 8320	Lastik	3/8"	10.000 psi	20.000 psi	3/8 NPT	20	6

EAB SERİSİ / EAB SERIES

ÇABUK BAĞLANTI RAKORLARI QUICK COUPLERS

Yüksek kaliteli çabuk bağlantı rakorları.
High quality quick couplers.

P&P rakorlar, diş tipleri, küresel vanalı, pim vanalı tipleri mevcuttur.
Female(male)coupler in P&P, thread types, with ball valve, pin valve available.

Model	Max.Basınç Max. Pressure (psi)	Tip Type	Diş Thread	Art. No Art. No	Dişi Bağlantı Female Couplers	Art. No	Erkek Bağlantı Male Couplers	Not Note	
EAB201	10.000	Yüksek Akış High Flow		3/8 - 18 NPT	91132001	EAB201A	91132005	EAB201B	-
EAB202	10.000	Yüksek Akış High Flow		1/4 - 18 NPT	91132002	EAB202A	91132006	EAB202B	-
EAB203	10.000	Yüksek Akış High Flow		3/8 - 18 NPT	91132003	EAB203A	91132007	EAB203B	ESL-50 ile kullanılır.
EAB204	20.000	Ultra Yüksek Akış Ultra High Flow		1/4 BSP	91132004	EAB204A	91132008	EAB204B	-

Manifoldlar / Manifolds

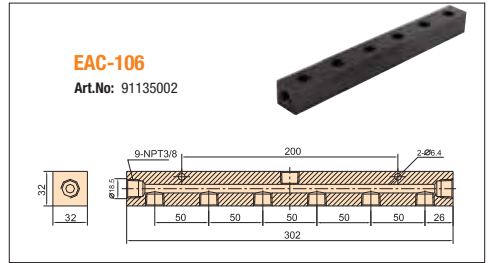
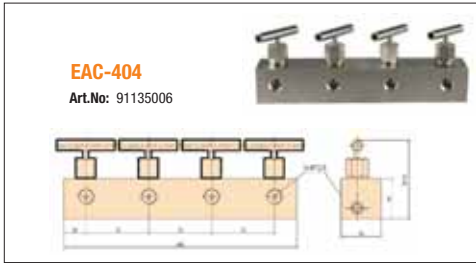
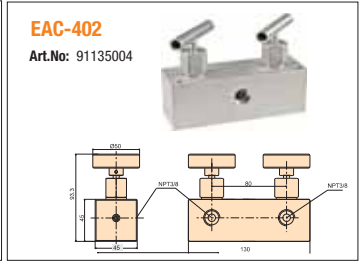
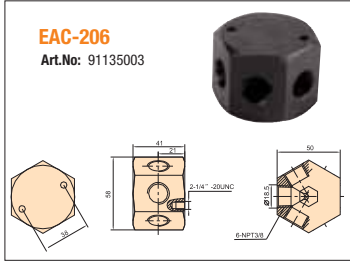
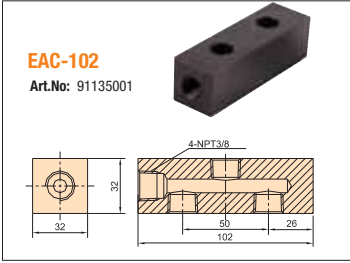

Tek tesirli sistem için / Single Acting Control Manifolds

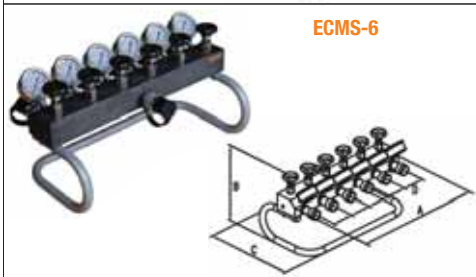
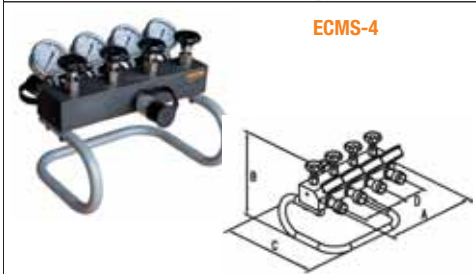
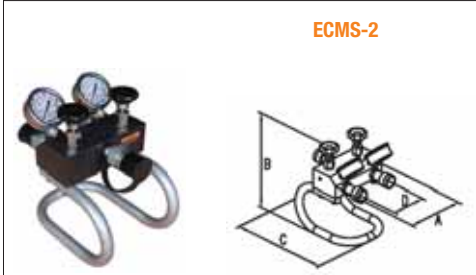



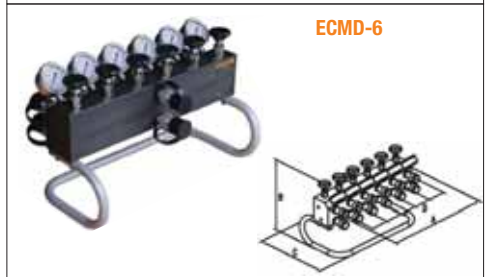
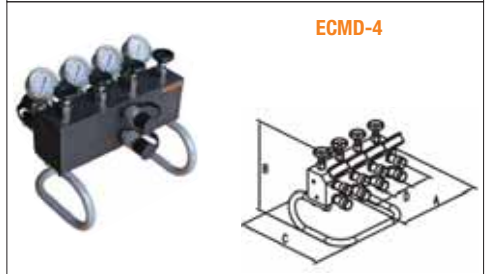
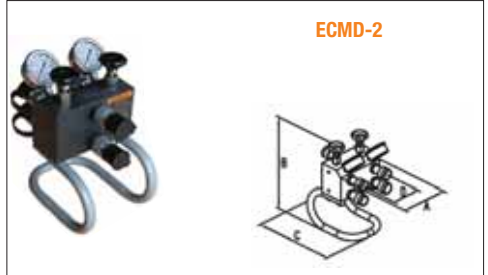





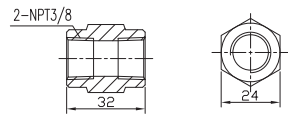

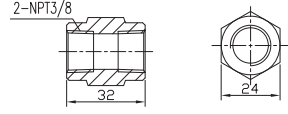

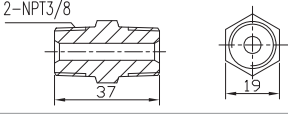

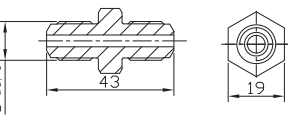

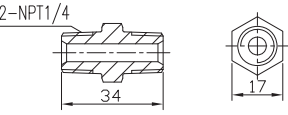

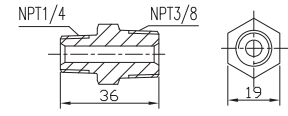

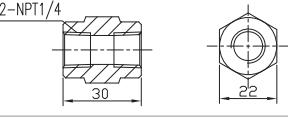
Çift tesirli sistem için / Double Acting Control Manifolds

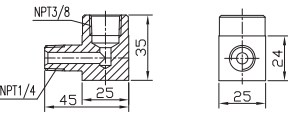

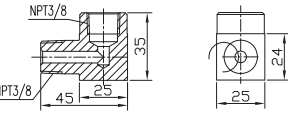
HİDROLİK KRİKO ve Ekip.
High Pressure Hydraulic Tools
And Equipments

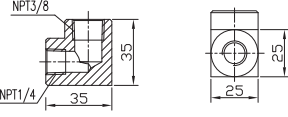
EFC SERİSİ / EFC SERIES**BAĞLANTILAR / FITTINGS**

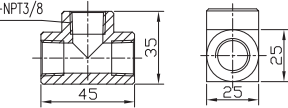
		Boyutlar / Dimensions (mm)	
EFC-11 Kod No: 91136005		Bağlantı 3/8-18 NPT Dişiden 3/8-18 NPT Dişiye Coupling From 3/8-18 NPT Female to 3/8-18 NPT Female	
EFC-12 Kod No: 91136006		Hexagon Uç 3/8-18 NPT Erkek, 3/8-18 NPT Erkek, Uzunluk:51mm Hexagon Nipple From 3/8-18 NPT male to, 3/8-18 NPT male, Length:51mm	
EFC-13 Kod No: 91136007		Hexagon Uç 3/8-18 NPT Erkek 3/8-18 NPT Erkek, Uzunluk: 38mm Hexagon Nipple From 3/8-18 NPTmale to 3/8-18 NPT male, Length: 38mm	
EFC-14 Kod No: 91136008		Hexagon Uç 1/4-BSP Erkek 1/4-BSP Erkek Hexagon Nipple From 1/4-BSP male to 1/4-BSP male	
EFC-15 Kod No: 91136009		Hexagon Uç 1/4-18 NPT Erkek 1/4-18 NPT Erkek Hexagon Nipple From 1/4-18 NPT male to 1/4-18 NPT male	
EFC-16 Kod No: 91136010		Hexagon Uç 1/4-18 NPT Erkek 3/8-18 NPT Erkek Hexagon Nipple From 1/4-18 NPT male to 3/8-18 NPT male	
EFC-181 Kod No: 91136011		1/4-18 NPT Dişi 1/4-18 NPT Dişi 1/4-18 NPT Female 1/4-18 NPT Female	
EFC-21 Kod No: 91136002		Dirsek 1/4-18NPT Erkekten 3/8-18 NPT Dişiye Elbow From 1/4-18 NPT Male to 3/8-18 NPT Female	
EFC-22 Kod No: 91136001		Dirsek 3/8-18 NPT Erkekten 3/8-18 NPT Dişiye Elbow From 3/8-18 NPT Male to 3/8-18 NPT Female	
EFC-23 Kod No: 91136003		Dirsek 1/4-18NPT Erkekten 3/8-18 NPT Dişiye Elbow From 1/4-18 NPT Male to 3/8-18 NPT Female	
EFC-31 Kod No: 91136004		T Bağlantı 3/8-18 NPT Dişi 3/8-18 NPT Dişiden 3/8-18 NPT Dişiye Tee From 3/8-18 NPT Female to 3/8-18 NPT Female and 3/8-18 NPT Female	

EG SERİSİ / EG SERIES

YÜKSEK BASINÇ GÖSTERGESİ / HIGH PRESSURE GAUGES



EG2510

EG4010

EG4016

Kod no Code No	Model	Basınç Aralığı Pressure Range		Dış Thread	Gösterge Çapı Gauge Diameter
		psi	mpa		mm
91137001	EG2510	0-10000	0-100	1/4 NPT	64
91137002	EG4010	0-10000	0-100	1/2 NPT	102
91137003	EG4016	0-23000	0-100	M20x1.5	102

Özellikler

- MPa ve psi birimlerinde çift okunmalı, kalibreli ve %1 hassasiyete sahiptir.
- Hızlı ve kolay monte edilebilir.
- Aseismatik (Hareketten etkilenmeyen).
- Paslanmaz çelik malzeme korozyon mukavemetlidir.

Features

- Calibrated with dual scale reading for MPa and psi accuracy, 1 %
- Fast, easy to install.
- Aseismatic- not affected by motion.
- Made of corrosion resistant stainless steel.

EGA SERİSİ / EGA SERIES

GÖSTERGE ADAPTÖRLERİ / GAUGE ADAPTORS

EGA-002/EGA-003/EGA-011

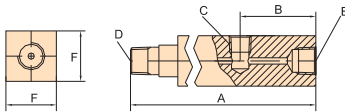

EGA-005

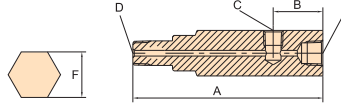

Kod no Code No	Model	Dışı Bağlantı Dişi Female Coupler Thread	Erkek Bağlantı Dişi Male Coupler Thread	Gösterge Diş Gauge Thread	Ölçüler Sizes (mm)					
		NPTF	NPTF		NPTF	A	B	C	D	E
91131002	EGA002	3/8" NPT	3/8" NPT	1/2" NPT	55	35	1/2" NPT	3/8" NPT	3/8" NPT	2
91131003	EGA003	3/8" NPT	3/8" NPT	1/4" NPT	133	48	1/4" NPT	3/8" NPT	3/8" NPT	32
91131004	EGA004	3/8" NPT	1/4" NPT	1/2" NPT	111	35	1/2" NPT	1/4" NPT	3/8" NPT	32
91131005	EGA005	3/8" NPT	3/8" NPT	1/4" NPT	134	35	1/4" NPT	3/8" NPT	3/8" NPT	32
91131006	EGA011	1/4" NPT	3/8" NPT	1/4" NPT	133	48	1/4" NPT	3/8" NPT	1/4" NPT	32



EV SERİSİ / EV SERIES





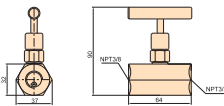

YÖN KONTROL VALFLER DIRECTIONAL CONTROL VALVES

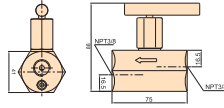
Soldan sağa doğru modeller
Shown from left to right
EV 43M4, EV 11, EV 52H3, EV 23

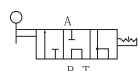
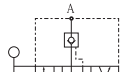

Art. No

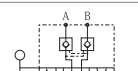
	Art. No Code No 91134001	EV-11 	İğne vana, silindir hızını manual olarak kontrol etme olanağı sağlar ve geçici yük tutma halinde kapatma vanası olarak da kullanılabilir. Needle valve, manually control the speed of cylinder, can be used as shut-off valve for temporary load holding.
	Art. No Code No 91134002	EV-23 	Manual çalıştırılan kontrol vanası, tek veya çift tesirli silindirlerde yük tutma amacıyla kullanılır, silindirler indiğinde yağın yağ haznesine dönüşünü sağlamak amacıyla manuel olarak açılır. Manually operated check valve, used to hold load with single or double acting cylinder, manually opened to allow oil to flow back to oil reserve when cylinder retracts.

Kullanıldığı Silindir Used With Cylinder	Valf Çalışması Valve Operation	Valf Konumu Valve Location	Kod no Code No	Model	Valf Tipi Valve Type	Valf Fonksiyonu Valve Function	Hidrolik Sembol Hydraulic Symbol	Ağırlık Weight (kg)
Tek Tesirli Single Acting	Manuel	Pompa Üzerinde Pump Mounted	91134004	EV 42H2	2 Pozisyon 2 Position	İleri- Geri Advance Return		2
	Manuel	Pompa Üzerinde Pump Mounted	91134005	EV 43M3	3 Pozisyon 3 Position	İleri- Tutma-Geri Advance Hold Return		1.3
	Manuel	Kumanda Üzerinde Remote Mounted	91134006	EV 43M3L	3 Pozisyon 3 Position	İleri- Tutma-Geri Advance Hold Return		2.2
	Manuel	Pompa Üzerinde Pump Mounted	91134007	EV 43M3T	3 Pozisyon 3 Position	İleri- Tutma-Geri Advance Hold Return		3.8
	Manuel	Kumanda Üzerinde Remote Mounted	91134008	EV 43M3LT	3 Pozisyon 3 Position	İleri- Tutma-Geri Advance Hold Return		4.7
	Selenoid 24V	Pompa Üzerinde Pump Mounted	91134009	EV 52H2	2 Pozisyon 2 Position	İleri- Geri Advance Return		1.8
	Selenoid 24V	Pompa Üzerinde Pump Mounted	91134010	EV 52H3	2 Pozisyon 2 Position	İleri- Geri Advance Return		1.8
Çift Tesirli Double Acting	Manuel	Pompa Üzerinde Pump Mounted	91134011	EV 43M4	3 Pozisyon 3 Position	İleri- Tutma-Geri Advance Hold Return		1.3
	Manuel	Kumanda Üzerinde Remote Mounted	91134012	EV 43M4L	3 Pozisyon 3 Position	İleri- Tutma-Geri Advance Hold Return		2.2
	Manuel	Pompa Üzerinde Pump Mounted	91134013	EV 43M4T	3 Pozisyon 3 Position	İleri- Tutma-Geri Advance Hold Return		3.8
	Manuel	Kumanda Üzerinde Remote Mounted	91134014	EV 43M4LT	3 Pozisyon 3 Position	İleri- Tutma-Geri Advance Hold Return		4.7
	Selenoid 24V	Pompa Üzerinde Pump Mounted	91134015	EV 52H4	2 Pozisyon 2 Position	İleri- Geri Advance Return		1.8

HİDROLİK KRİKO VE EKİP.
High Pressure Hydraulic Tools
And Equipments



ENS SERİSİ / ENS SERIES

HİDROLİK SOMUN KESİCİ

HYDRAULIC NUT SPLITTERS

Soldan sağa doğru modeller / Shown from left to right
ENS-001, ENS-002, ENS-003, ENS-004, ENS-005,
ENS-006,ENS-007



Özellikler

- Dar alanlarda kullanım için kompakt tasarım.
- Özel kafa açısı tasarımı.
- Tek tesirli, yay dönüşlü silindirlir.
- Somun ayırıcı bıçaklar değiştirilebilir.

Features

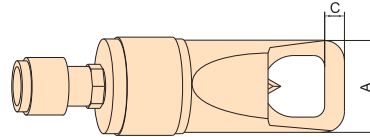
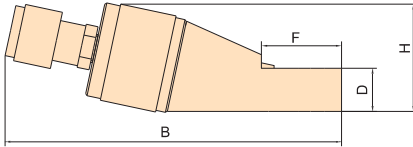

- Compact design for use in confined spaces.
- Unique angled head design.
- Single-acting, spring return cylinder.
- Nut splitter blade can be replaced.



Art.No Code No	Model	Cıvata Aralığı Bolt Range	Hekzagon Aralığı Hex. nut range	Kapasite Capacity	Yağ Kapasitesi Oil Capacity	Boyutlar / Dimensions						Ağırlık / Weight
						A	B	C	D	F	H	
91128001	ENS001	8-13	12.7-19.1	5	15	40	190	8	19	30	51	1.2
91128002	ENS002	13-16	19.1-23.9	10	20	53	215	10	25	40	65	2
91128003	ENS003	16-22	26.9-31.8	15	30	66	245	13	30	55	80	3.2
91128004	ENS004	22-29	36.6-41.4	20	52	75	285	17	36	67	92	4.5
91128005	ENS005	29-35	46.0-50.8	35	116	93	340	21	43	86	114	8.3
91128006	ENS006	35-38	50.8-57.2	50	181	106	370	23	52	100	128	13.9
91128007	ENS007	38-48	60.5-73.2	90	458	154	450	26	75	125	190	35

SİLİNDİR AKSESUARLARI / CYLINDER ACCESSORIES

OYNAR PİSTON BAŞLIĞI / TILT SADDLE

Başlıklar				
Silindir serisi Cylinder Series	Kapasite Capacity	Oynar Başlık Tilt	Yivli Başlık Grooved Head	Ortası Delik Başlık Hole Head
				
		Oynar Başlık Tilt	Yivli Başlık Grooved head	Ortası Delik Başlık Hole Head
ES	5		SG-53G	
	10	ST-10*	SG-102G	
	15	ST-10	SG-152G	
	25	ST-50	SG-252G	
	30	ST-50	SG-252G	
	50	ST-100		
	75	ST-100		
ESL*	10			
	20-100			
ESL**	20			SH-2015
ESH/EDH	30			SH-3015
ESH/EDH	60			SH-5016
ESH/EDH	10			SH-10016
ED	30	ST-50		
	50	ST-100		
	75	ST-100		
ESX/EDX	50	ST-50		
	100	STX-100		
	150	STX-150		
	200	STX-200		
	250	STX-250		
	300	STX-300		
	400	STX-400		
	500	STX-500		
	600	STX-600		
	800	STX-800		
1000	STX-1000			
EL	50-100	ST-100		
	150-200	ST-200		
	250	ST-250		
	300	ST-300		
	400	ST-400		
	500	ST-500		
	600	ST-600		

*ES-101 Dışında

**ESL düşük profilli silindirler ile kullanılır.

Art. No Code No	Model	A	B	C	D	E
		mm	mm	mm	mm	mm
91136012	ST- 10	35	17	21	-	-
91136013	ST- 50	49	23	36	-	-
91136014	ST- 100	71	24	37	44	71
91136015	ST- 200	129	20	45	105	129
91136016	ST- 250	149	21	46	125	149
91136017	ST- 300	195	75	100	112	139
91136018	ST- 400	225	85	110	133	159
91136019	ST- 500	248	91	116	150	179
91136020	ST- 600	275	96	121	166	194
91136021	ST- 800	318	123	148	197	224
91136022	ST- 1000	357	135	161	221	249
91136023	STX - 50	49	23	43	39	49
91136024	STX - 100	72	29	48	55	74
91136025	STX - 150	91	31	50	74	94
91136026	STX - 200	118	35	59	90	113
91136027	STX - 250	144	46	70	119	145
91136028	STX - 300	158	62	81	150	177
91136029	STX - 400	193	51	78	170	196
91136030	STX - 500	228	63	90	200	228
91136031	STX - 600	241	76	103	220	246
91136032	STX - 800	296	75	102	260	297
91136033	STX - 1000	310	93	119	295	323

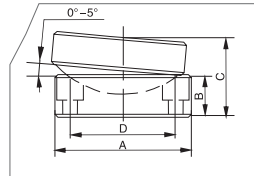
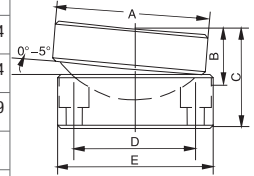
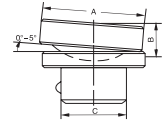

EHS - EFS SERİSİ / EHS-EFS SERIES**HİDROLİK AYIRICI
HYDRAULIC SPREADERS**

EHS-0.75

EHS-1

EHS Özellikler

- EHS serisinde tek tesirli, yay dönüşlü silindir kullanılır.
- Basınç ortadan kalktığı zaman ağız kendiliğinden kapanır.
- Ürün üzerinde dişi kaplin ve toz kapağı bulunur.
- Uzun stroklu ayırma işlemi için EHS-075
- Dar alan kullanımı için EHS-1
- ANSI / ASME B 30.1 Standartlarına uygundur.

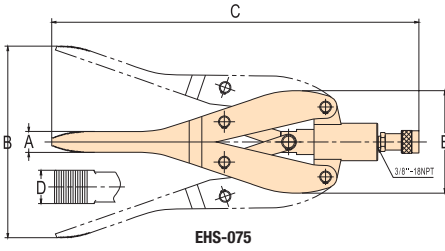

EHS-075

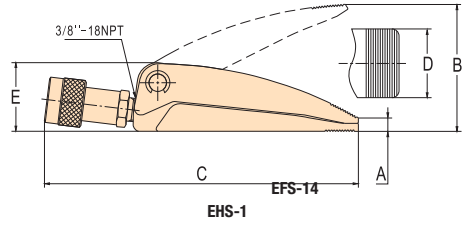

EHS-1

EFS Özellikler

- EFS serisinde tek tesirli, yay dönüşlü silindir kullanılır.
- Basınç ortadan kalktığı zaman ağız kendiliğinden kapanır.
- Emniyet takozu ve toz kapaklı dişi kaplin vardır.
- ANSI / ASME B 30.1 Standartlarına uygundur.

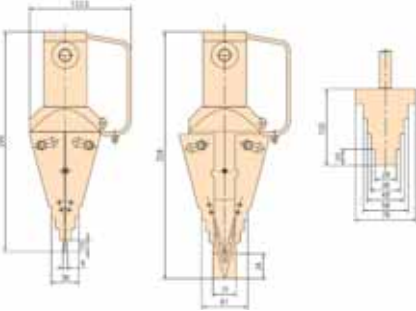

EFS-14

Art.No Code No	Model	Kapasite	Yağ Kapasitesi	Silindir	A	B	C	D	E	Ağırlık Weight
		Capacity	Oil Capacity	Etkif Alanı						
		ton	cm ³	cm ²	mm	mm	mm	mm	mm	kg
91141001	EHS-1A	1.1	13,6	6,5	11,94	100,1	231	56	56	2.5
91141002	EHS-075	0.75	55,1	14,5	32	292,1	559	51	157	12.5
91141003	EFS -14	14	78,4	14,5	6,1	81	290	67	134	7,2

EB SERİSİ / EB SERIES

HİDROLİK GERDİRME HYDRAULIC TENSIONER

EB 206 - EB 207

Art. No	Model	Yük Hücresi Modeli Load Cell Model	Cıvata Ölçüsü Bolt Size	Yük	Adaptör & Köprü Kit Modeli Adaptor & Bridge Kit Model	
				Load		
				KN		
91129001	EB201	EB201LC	M20	155		EB201AK-M20
			M22			EB201AK-M22
			3/4			EB201AK-3/4
			7/8			EB201AK-7/8
91129002	EB202	EB202LC	M24	456		EB202AK-M24
			M27			EB202AK-M27
			M30			EB202AK-M30
			M33			EB202AK-M33
			M36			EB202AK-M36
			1			EB202AK-1
			1-1/8			EB202AK-1-1/8
			1-1/4			EB202AK-1-1/4
1-3/4	EB202AK-1-3/4					
91129003	EB203	EB203LC	M39	763		EB203AK-M39
			M42			EB203AK-M42
			1-1/2			EB203AK-1-1/2
			1-5/8			EB203AK-1-5/8
91129004	EB204	EB204LC	M45	989		EB204AK-M45
			M48			EB204AK-M48
			1-3/4			EB204AK-1-3/4
			1-7/8			EB204AK-1-7/8
91129005	EB205	EB205LC	M52	1346		EB205AK-M52
			M56			EB205AK-M56
			2			EB205AK-2
			2-1/4			EB205AK-2-1/4
91129006	EB206	EB206LC	M60	1649		EB206AK-M60
			M64			EB206AK-M64
			M68			EB206AK-M68
			2-1/2			EB206AK-2-1/2
			M72			EB207AK-M72
91129007	EB207	EB207LC	M76	2191		EB207AK-M76
			2-3/4			EB207AK-2-3/4
			3			EB207AK-3
			M80			EB208AK-M80
91129008	EB208	EB208LC	M85	2544		EB208AK-M85
			M90			EB208AK-M90
			3-1/4			EB208AK-3-1/4
			3-1/2			EB208AK-3-1/2
			M95			EB209AK-M95
91129009	EB209	EB209LC	M100	3101		EB209AK-M100
			3-3/4			EB209AK-3-3/4
			M105			EB210AK-M105
91129010	EB210	EB210LC	M110	3796		EB210AK-M110
			M115			EB210AK-M115

EB SERİSİ / EB SERIES**HİDROLİK GERDİRME
HYDRAULIC TENSIONER****Özellikler**

- 10 yük hücresi mevcuttur.
- Hafif ve hassasiyeti yüksektir.
- Tam görüntü için köprü penceresi bulunur.Farklı cıvatalar için değiştirilebilir yük hücresine sahiptir.
- Köprüler kolay montaj için çıkarılabilir ve döndürülebilir yapıdadır.

Features

- 10 Load cells available.
- Light weight, and accurate.
- Bridge window for full viewing.
- Removable load cell for different sized bolts.
- Bridges are removable and rotate for easy installation.

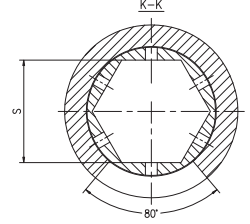
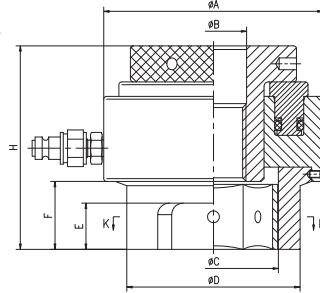

Boyutlar / Dimensions								Strok Stroke
A mm	B mm	C mm	D mm	E mm	F mm	H mm	S mm	mm
80	20.5	43	62	16	23	91	31	9.9
		45					33	
		43					31	
		45					33	
110	25	54	73	18	37	111	37	
	28	57	75	20	30	114	42	
	31	62	81	20	32	116	47	
	34	69	88	20	35	119	51	
	37	74	96	26	38	122	56	
	28	57	75	20	30	114	39	
	31	62	81	20	32	116	44	
134	34	69	88	20	35	119	49	
	37	74	96	26	38	122	53	
	40	80	100	28	41	133	61	
	43	85	108	30	44	136	66	
	40	80	100	28	41	133	58	
152	43	85	108	30	44	136	63	
	46	90	120	32	47	141	71	
	49	95	125	32	50	144	76	
	46	90	120	32	47	141	68	
177	49	95	125	32	50	144	76	
	53	103	132	38	54	154	81	
	57	106	140	38	58	158	86	
	53	103	132	38	50	144	77	
200	59	115	150	41	62	164	90	
	61	115	150	41	62	164	91	
	65	120	156	45	66	168	96	
	69	126	164	45	70	172	101	
	65	126	164	45	70	172	100	
225	73	135	185	50	74	189	106	
	77	140	190	52	78	193	111	
	72	140	190	52	78	193	109	
	78	146	206	60	82	202	118	
255	81	146	206	60	82	202	116	
	86	155	210	60	87	207	121	
	91	165	225	60	92	212	131	
	84	165	225	60	92	212	128	
	92	173	235	65	98	224	137	
282	97	173	235	65	98	224	136	
	102	186	245	70	103	229	146	
	97	186	245	70	103	229	147	
320	-	197	275	70	107	242	152	
	-	202	275	75	112	247	157	
	-	212	275	80	117	252	167	

ESW SERİSİ / ESW SERIES

KARE BAŞLIKLİ HİDROLİK TORK ANAHTARI TORQUE WERNCH



Yağ giriş noktası 360°
dönme özelliğine sahiptir.
Swiveling inlet port rotates
360 degrees

360° ince ayar tipi
reaksiyon kolu
360° fine-tune type
reaction arm

Özellikler

- 70 Mpa max. çalışma basıncı \pm % 3 hassasiyete sahiptir.
- 189 Nm - 48670 Nm aralığında 8 model, bir çok civata ölçüsünü kapsar.
- Bağlantı için kullanılan kare başlık tipi ile hızlı bir şekilde aparat değişikliği yapılabilir.
- 360° dönebilen bağlantı noktası rahat çalışma olanağı sağlar.
- Isıl işlem uygulanmıştır.

Features

- 70Mpa Max working pressure and the accuracy keep within \pm 3%.
- All together 8 models with the range from 189 N.m to 48670 N.m Which covers most bolts size, and becomes the comprehensive available in the market
- The square drive operate with the high intense socket and suitable with large rangers of bolts
- 360 degree adjustable reaction arm allows placing freely.
- Well heat-treated, lifetime warranty.



Hızlı ve verimli çalıştırma 35°
dönüş açısı ve hızlı geri dönüş
stroku
Fast and efficient operation. 35°
rotation angle and fast return stroke

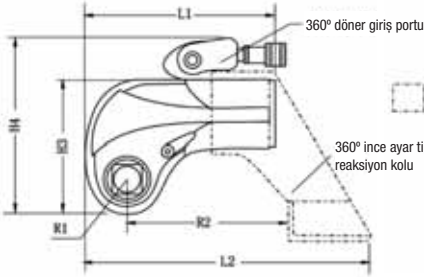

Art. No Code No	Model	Kare başlık ebadı Square drive	Tork kapasitesi Tension range	Civata/Somun aralığı Bolts range	Ağırlık Weight	L1	L2	H1	H2	H3	H4	R1	R2
		in	N.m	mm	kg	mm	mm	mm	mm	mm	mm	mm	mm
91126001	ESW-1	3/4"	189-1897	16-36	2	130	182	50	72	99	144	26	99
91126002	ESW-3	1"	450-4510	22-48	4	166	241	68	95	130	176	34	134
91126003	ESW-5	1-1/2"	737-7368	27-56	7	198	281	80	123	155	198	39	152
91126004	ESW-8	1-1/2"	1078-10784	30-64	9,1	213	308	90	130	171	216	47	171
91126005	ESW-10	1-1/2"	1550-15503	36-72	13,1	231	336	100	141	187	230	51	174
91126006	ESW-20	2-1/2"	2666-26658	42-90	25	295	443	120	182	228	268	59	250

DİKKAT : Uygulamanız için doğru tork anahtarını modelini seçtiğinizden emin olunuz. Gevşetme torku, sıkma torkundan yaklaşık %250 daha fazla tork gerektirir.

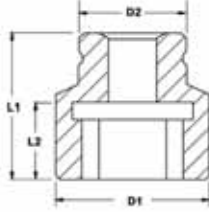
ESWT SERİSİ / ESWT SERIES**KARE BAŞLI HİDROLİK TORK ANAHTARI SOKETLERİ**
SOCKETS FOR SQUARE DRIVE HYDRAULIC TORQUE WRENCH**Özellikler**

- Yüksek standart krom alaşım malzemeden yapılmıştır.
- Standart ısı işlem ve özel işlem görmüştür.

Features

- Made of high standard chromium alloy material.
- With a standard heat treatment, long-life treatment.

Art No Code No	Model	Tork Anahtar Modeli Wrench Model	Kade Başlık Ebadı Size	Civata Ölçüsü Bolts size	Çapraz Ölçü Across Side	L1	L2	D1	D2		
						mm	mm	mm	mm		
91170101	ESWT-75024	ESW-1	3/4"	M16	24	54	32	40	40		
91170102	ESWT-75027			M18	27	54	32	42	42		
91170103	ESWT-75030			M20	30	54	33	46	44		
91170104	ESWT-75034			M22	34	54	32	48	44		
91170105	ESWT-75036			M24	36	57	32	53	44		
91170106	ESWT-75041			M27	41	58	33	60	44		
91170107	ESWT-75046			M30	46	63	38	66	44		
91170108	ESWT-75050			M33	50	65	40	71	44		
91170109	ESWT-75055			M36	55	70	45	77	54		
91170046	ESWT-10030			ESW-3	1"	M20	30	59	32	54	54
91170047	ESWT-10034	M22	34			59	32	58	58		
91170048	ESWT-10036	M24	36			62	32	59	59		
91170049	ESWT-10041	M27	41			65	38	67	54		
91170050	ESWT-10046	M30	46			65	38	74	54		
91170051	ESWT-10050	M33	50			70	43	79	60		
91170052	ESWT-10055	M36	55			80	52	84	60		
91170053	ESWT-10060	M39	60			85	57	89	60		
91170054	ESWT-10065	M42	65			85	58	98	70		
91170055	ESWT-10070	M45	70			90	62	104	70		
91170056	ESWT-10075	M48	75	95	65	108	70				
91170057	ESWT-15036	ESW-5	1-1/2"	M24	36	85	44	74	74		
91170058	ESWT-15041			M27	41	85	44	74	74		
91170059	ESWT-15046			M30	46	85	44	74	74		
91170060	ESWT-15050			M33	50	90	45	79	79		
91170061	ESWT-15055			M36	55	90	45	84	84		
91170062	ESWT-15060			M39	60	100	45	94	84		
91170063	ESWT-15065			M42	65	100	45	98	80		
91170064	ESWT-15070			M45	70	105	50	104	80		
91170065	ESWT-15075			M48	75	110	50	118	85		
91170066	ESWT-15080			M52	80	115	55	118	90		
91170067	ESWT-15085	M56	85	125	60	128	90				
91170068	ESWT-15090	M60	90	125	60	139	90				
91170069	ESWT-15095	M64	95	130	65	139	90				
91170070	ESWT-15100	ESW-10	2-1/2"	M68	100	135	70	144	90		
91170071	ESWT-15105			M72	105	135	70	149	90		
91170072	ESWT-15110			M76	110	135	70	158	90		
91170073	ESWT-15115			M80	115	135	70	159	90		
91170074	ESWT-15120			M85	120	135	70	168	95		
91170075	ESWT-15130			M90	130	155	93	189	95		
91170081	ESWT-25055			ESW-20	2-1/2"	M36	55	100	57	86	114
91170082	ESWT-25060					M39	60	100	52	119	119
91170083	ESWT-25065					M42	65	100	52	119	119
91170084	ESWT-25070					M45	70	120	67	128	128
91170085	ESWT-25075	M48	75			120	67	128	128		
91170086	ESWT-25080	M52	80			130	71	128	128		
91170087	ESWT-25085	M56	85			130	71	129	129		
91170088	ESWT-25090	M60	90			140	73	139	139		
91170089	ESWT-25095	M64	95			140	73	139	139		
91170090	ESWT-25100	ESW-25	2-1/2"			M68	100	140	81	148	130
91170091	ESWT-25105			M72	105	150	89	149	130		
91170092	ESWT-25110			M76	110	150	90	158	130		
91170093	ESWT-25115			M80	115	150	98	168	130		
91170094	ESWT-25120			M85	120	150	98	178	130		
91170095	ESWT-25130			ESW-35	2-1/2"	M90	130	170	98	188	130
91170096	ESWT-25135					M95	135	170117	114	198	130
91170097	ESWT-25145					M100	145	0	122	210	152
91170098	ESWT-25150					M105	150	190	140	216	152
91170099	ESWT-25155					M110	155	190	140	229	152
91170100	ESWT-25165	M115	165			190	140	241	152		

EHW SERİSİ / EHW SERIES

HEKZAGON TORK ANAHTARI

HEXAGON TORQUE WERNCH

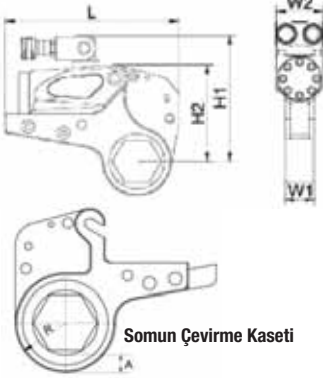

Somun Çevirme Kaseti

Özellikler

- 70 Mpa max. çalışma basıncı ve \pm %3 hassasiyete sahiptir.
- 228 - 44613 Nm aralığında 5 model
- 360°*180 ve 360°*360° döner yapısı ile yer sıkıntısı olmadan çalışma imkanı sağlar.
- Tork anahtarı somun üzerinde daha hassas ve kolay çalışır.
- Uzun kolu ve kompakt gövdesi ile rahat kullanım kolaylığı sağlar.

Features

- 70Mpa Max working pressure and the accuracy keep within \pm 3%.
- 5 with range from 228-44613 N.m.
- 360°*180 degree swivel & 360°*360 degree swivel allow the wrench free to operate with space limitation.
- More accurate and easier for the wrench to work directly on the nuts.
- Compact design with long arm fully advances the reliability.

Yağ giriş noktası 360° dönme özelliğine sahiptir. Swiveling inlet port rotates 360 degrees



Hızlı bağlantı değişimini sağlayan tasarım. Simple, tool free design for fast link changes on the job site



Hızlı ve verimli çalıştırma 35° dönüş açısı ve hızlı geri dönüş stroku

Fast and efficient operation. 35° rotation angle and fast return stroke

Tork Anahtarı Tablosu

Art. No Code No	Model	Tork	Altıgen	Güç Ünitesi	Kaset	L	H1	H2	W1	W2
		Kapasitesi Torque range	Soket Ebadı Bolt across side	Aralığı Power unit	Aralığı Cassette					
		Nm	s	kg	kg	mm	mm	mm	mm	mm
91127001	EHW-2	228-2278	1955	1	1.6	196.4	125.9	102.3	32	51
	EHW-2S0	243-2427	60	1	1.7	196.4	128.5	105	32	51
91127002	EHW-4	586-5862	34-65	2	4.4	245	177	135.7	42	66
	EHW-4S0	643-6437	70-80	2	4.6	246	187	145.7	42	66
91127003	EHW-8	1103-11981	41-95	3.3	8	300	207	169	53	83
	EHW-8S0	1181-11807	100-105	3.3	8.4	301	216	178	53	83
91127004	EHW-14	1560-15653	50-117	5.5	11.6	361	239	204	64	99

DIKKAT : Uygulamanız için doğru tork anahtarı modelini seçtiğinizden emin olunuz.

Gevşetme torku, sıkma torkundan yaklaşık %250 daha fazla tork gerektirir.

Kaset Tablosu

Cıvata başı Somun ölçüsü Bolts dia. mm	EHW-2	EHW-4	EHW-8	EHW-14
	Kaset modeli Cassette model	Kaset modeli Cassette model	Kaset modeli Cassette model	Kaset modeli Cassette model
19	EHWL2-34			
21	EHWL2-1316			
22	EHWL2-78			
24	EHWL2-1516			
25	EHWL2-1	EHWL4-1		
27	EHWL2-1116	EHWL4-1116		
29	EHWL2-118	EHWL4-118		
30	EHWL2-1316	EHWL4-1316		
32	EHWL2-114	EHWL4-114		
33	EHWL2-11516	EHWL4-11516		
35	EHWL2-138	EHWL4-138		
36	EHWL2-1716	EHWL4-1716		
38	EHWL2-112	EHWL4-112		
40	EHWL2-1916	EHWL4-1916		
41	EHWL2-158	EHWL4-158		
43	EHWL2-11116	EHWL4-11116		
44	EHWL2-134	EHWL4-134		
46	EHWL2-1316	EHWL4-1316		
48	EHWL2-178	EHWL4-178	EHWL8-178	
49	EHWL2-11516	EHWL4-11516	EHWL8-11516	
50	EHWL2-2	EHWL4-2	EHWL8-2	
52	EHWL2-2116	EHWL4-2116	EHWL8-2116	
54	EHWL2-218	EHWL4-218	EHWL8-218	
55	EHWL2-2316	EHWL4-2316	EHWL8-2316	
57	EHWL2-214	EHWL4-214	EHWL8-214	
59	EHWL2-2516	EHWL4-2516	EHWL8-2516	
60	EHWL2-238	EHWL4-238	EHWL8-238	EHWL14-238
62	EHWL4-2716	EHWL8-2716	EHWL14-2716	
63	EHWL4-212	EHWL8-212	EHWL14-212	
75	EHWL4-2916	EHWL8-2916	EHWL14-2916	
67	EHWL4-258	EHWL8-258	EHWL14-258	
68	EHWL4-21116	EHWL8-21116	EHWL14-21116	
70	EHWL4-234	EHWL8-234	EHWL14-234	
71	EHWL4-21316	EHWL8-21316	EHWL14-21316	
73	EHWL4-278	EHWL8-278	EHWL14-278	
75	EHWL4-21516	EHWL8-21516	EHWL14-21516	
76	EHWL4-3	EHWL8-3	EHWL14-3	
78	EHWL4-3116	EHWL8-3116	EHWL14-3116	
80	EHWL4-318	EHWL8-318	EHWL14-318	
81		EHWL8-3316	EHWL14-3316	
83		EHWL8-314	EHWL14-314	
84		EHWL8-3516	EHWL14-3516	
85		EHWL8-338	EHWL14-338	
87		EHWL8-3716	EHWL14-3716	
91		EHWL8-312	EHWL14-312	
92		EHWL8-3916	EHWL14-3916	
94		EHWL8-359	EHWL14-358	
95		EHWL8-31116	EHWL14-31116	
97		EHWL8-334	EHWL14-334	
98		EHWL8-31316	EHWL14-31316	
100		EHWL8-378	EHWL14-378	
102		EHWL8-31516	EHWL14-31516	
103		EHWL8-4	EHWL14-4	
105			EHWL14-4116	
106			EHWL14-418	
108			EHWL14-4316	
110			EHWL14-414	
111			EHWL14-4516	
113			EHWL14-438	
114			EHWL14-4716	
116			EHWL14-412	
117			EHWL14-4916	
			EHWL14-458	



Özellikler

- Başlıkların ebadını küçültmek için daraltıcı burçlar kullanılır.
- Çok güçlü alaşım malzemeden mamüldür.

Tork Anahtar Modeli Wrench model	Kaset Modeli Cassette Model	Kaset Cıvata Başlı / Somun Ölçüsü Link Bolt Head/Nut Size mm	Burç modeli Reducer Model	Burç Cıvata Başlı Somun Ölçüsü Reducer Bolt Head/Nut Size mm
EHW-2	EHWL2-1716	36	E23628	29
			EHWL2-158	41
	EHWL2-11316	46		
			E24622	27
			E24632	32
			E24636	36
	EHWL2-2	50	E25032	32
			E25036	36
			E25041	41
	EHWL2-2316	55	E25536	36
			E25541	41
			E25546	46
	EHWL2-238	60	E26041	41
			E26046	46
E26050			50	
EHW-4	EHWL4-2	50	E45047	48
			EHWL4-2316	55
	E45541	41		
	E45546	46		
	EHWL4-238	60	E46035	35
			E46036	36
			E46046	46
	EHWL4-2716	62	E46050	50
			E46346	46
			EHWL4-212	63
	E46334	52		
	EHWL4-2916	65	E46546	46
			E46550	50
			E46554	54
E46555			55	
EHWL4-234	70	E47050	50	
		E47055	55	
		E47060	60	
EHWL4-21516	75	E47550	50	
		E47555	55	
		E47560	60	
EHWL4-318	80	E47565	65	
		E48050	50	
		E48054	54	
		E48060	60	
		E48065	65	
		E48070	70	
E48075	75			

EHW SERİSİ / EHW SERIES

DARALTICI BURÇLAR CASSETTE REDUCER

Features

- Super strong alloy making.
- Customizability of all kinds of spacer shell.

Tork Anahtar Modeli Wrench model	Kaset Modeli Cassette Model	Kaset Cıvata Başlı / Somun Ölçüsü Link Bolt Head/Nut Size mm	Burç modeli Reducer Model	Burç Cıvata Başlı Somun Ölçüsü Reducer Bolt Head/Nut Size mm
EHW-8	EHWL8-2916	65	E86550	50
			EHWL8-234	70
	E87055	55		
	E87060	60		
	EHWL8-21516	75	E87555	55
			E87560	60
			E87565	65
	EHWL8-318	80	E88050	50
			EE88055	55
			E88060	60
			E88065	65
	EHWL8-312	89	E88070	70
			E89070	70
			E89075	75
EHWL8-312	89	E89076	76	
		E89080	80	
		EHWL8-31116	94	E89370
EHWL8-334	95			E89570
		EHWL8-378	98	E89575
E89580	80			
EHW-14	EHWL14-3	76	E147654	29
			EHWL14-318	80
	E148065	65		
	E148070	70		
	EHWL14-312	89	E149075	59
			E149070	70
	EHWL14-31116	94	E149080	80
			E149575	59
			E149570	70
	EHWL14-378	98	E149580	80
			E140075	75
			E140080	80
	EHWL14-378	98	E140090	89
			E1411090	89
EHWL14-414			108	E1411095
	E14110100	98		
EHWL14-458	117	E1411795	94	
		E14117100	98	
		E14117110	108	

TWP SERİSİ / EHW SERIES

HİDROLİK TORK ANAHTAR POMPASI HYDRAULIC TORQUE WRENCH PUMPS

Kablolu uzaktan kumanda
Hand held remote control for easy operation

Pompa üzerinde standart aksesuar olarak dahili yağ soğutucu bulunmaktadır.
This pump comes with built-in oil cooling as a standard feature enabling you to be more productive.

İstenen tork seviyesine ulaşmak için basıncı ayarlamaya yarayan kilitlenebilir basınç valfi
Fully adjustable and lockable pressure valve, Allows you to set the pressure you need to achieve the right amount of torque

Yüksek mukavemetli, hafif ve alüminyum alaşım hazne ve pompa gövdesi
High strength, tight weight, aluminum alloy reservoir and pump body making it extremely portable



Yüksek verimli TEFC endüksiyon motoru
High efficiency TEFC induction motor starts under the toughest loads

Basınç göstergesi ve yağ seviye görüşü
Easy to read pressure gauge and oil level sight ensure your pump is working properly

4 çıkışlı vana, 2 adet tork anahtarının aynı anda çalışmasına müsaade eder.
4 Port valve design allows operation of 2 torque wrenches at the same time

Dayanımlı yüksek mukavemetli alüminyum pompa kafesi zor şartlarda pompayı korur.
High strength aluminum roll cage protects the pump in the harshest environments

Art. No	Tork Anahtarı Sayısı Wrench Quantity	Model	Akış Oranı / Flow Rate l / dk			Yağ Kapasitesi Oil Capacity l	Hazne Ölçüsü Reservoir Size mm	Motor	Ağırlık (Yağsız) Weight (Without oil)
			1. Kademe 1. Stage	2. Kademe 2. Stage	3. Kademe 3. Stage				kg
91124021	1 veya 2 / 1 or 2	TWP - 3AF	8	1.52	0.76	6	430*330*472	220V, 50HZ, 1.3HP	27.5

Tork Anahtarı için Hidrolik Hortum Hydraulic Hose for torque wrench



Tork Anahtarı için Hidrolik Hortum Hydraulic Hose for torque wrench

Art No Code No	Model	Uzunluk / Length (m)
91170043	EH - 15	4.5
91170044	EH - 20	6.0
91170045	EH - 40	12.0

Çubuk Bağlantıları Quick Coupler



Art No Code No	Model	Diş Ölçüsü Screw Model	Tanım Description
91132013	EAB - 202 TA	1/4 - 18 NPT	Dişi / Female
91132014	EAB - 202 TB		Erkek / Male
91132015	EAB - 202 T		Dişi&Erkek / Female&Male

ÇEVİRİM TABLOSU / CONVERSION TABLE

	Çarpan By	Birim To Get	Çarpan By	Birim Unit
Birim Unit	Faktör Factor	Birim Unit	Faktör Factor	Birim Unit
Milimetre / Milimeter (mm) (1inch=25.4 mm)	x0.03937	=inc	x25.4	= mm
Santimetre / Centimeter (cm) 10mm	x0.3937	=inc	x2.54	= cm
Metre / Meter (m) 1000 mm	x3.28	=foot	x0.305	= m
Metre/ Meter (m)	x1.09	=yard	x0.914	= m
Kilometre / Kilometer (km) 1000m	x0.62	=mile	x1.61	= km
Milimetre / Milimeter (mm²)	x0.00155	=inch ²	x645	= mm ²
Santimetre / Centimeter (cm²)	x0.155	=inch ²	x6.45	= cm ²
Metre² / Meter² (m²)	x10.8	=foot ²	x0.0929	= m ²
Metre² / Meter² (m²)	x1.2	=yard ²	x0.836	= m ²
Hektare / Hectar (ha) 10.000 m²	x2.47	=acre	x0.405	= ha
Kilometre / Kilometer (km²)	x0.39	=mile ²	x2.59	= km ²
Santimetre / Centimeter (cm³)	x0.061	=inch ³	x16.4	= cm ³
Litre / Liters (l)	x61	=inch ³	x0.018	= L
Milimetre / Milimeter (ml)	x0.034	=fl oz	x29.6	= ml = 1cm ³
Litre / Liters (l) 1000 ml	x1.061	=guart	x0.946	= L
Litre / Liters (l)	x0.26	=gallon	x3.79	= L
Metre³ (m³) 1000l	x1.3	=yard ³	x0.76	= m ³
Litre-dakika / Liters-Min	x61.024	=cu.in/ min	x0.016	=liters/ min (litre/ dk)

	Çarpan By	Birim To Get	Çarpan By	Birim Unit
Birim Unit	Faktör Factor	Birim Unit	Faktör Factor	Birim Unit
Gram / Gram (g)	x0.035	=ounce	x28.3	= g
Kilogram / Kilogram (kg) 1000 g	x2.2	=pound	x0.454	= kg
Ton / Tonne (t) 1000 kg	x1.1	=short ton	x0.907	=T
Newton (N)	x0.225	=pound	x4.45	=N
Kilonewton	x225	=pound	x0.00445	=KN
Newtonmetre / newtonmeter (N.M)	x8.9	=lb. in.	x0.113	=N.m
Newtonmetre / newtonmeter (N.M)	x0.74	=lb. ft.	x1.36	=N.m
Kilopaskal (kPa)	x4.0	=in.H ₂ O	x0.249	=kPa
Kilopaskal (kPa)	x0.3	=in.Hg	x3.38	=kPa
Kilopaskal (kPa)	x0.145	=psi	x6.89	=kPa
Megapaskal (MPa)	x145	=psi	x0.00689	=MPa
Bar	x14.5	=psi	x0.0689	=Bar
Watt (kw)	x0.74	=ft.lb/s	x1.36	=kw
Kilowatt (kw)	x0.948	=Btu/s	x1.055	=kw
Kilowatt (kw)	x1.34	=hp	x0.746	=w
"F=(°C x 9/5)+32"		"°C=(F-32) x 5/9"		



NETMAK TEST MERKEZİ

200 ton - 8 metre Yatay Test Makinesi



- Çelik halat sapan, zincir sapan, polyester sapan gruplarının çekme ve koparma testleri için özel olarak tasarlanmıştır
- Test makinesi bilgisayarlı kontrol sistemi tarafından desteklenir.
- Diyagramlı olarak test sonuçlarının otomatik olarak print alınmasını sağlar.
- İş güvenliğini en iyi seviyede sağlamak üzere hidrolik çalışan koruma kapağı bulunur.
- Uzama ölçümü yapar.



1000 ton Hidrolik Test Makinesi

- 1 tondan 1000 tona kadar olan hidrolik - mekanik silindir ve krikoların kapasite testleri
- Pompa ve hortum sızdırmazlık ve kapasite testleri gerçekleştirilir.

