



■ **Manuel Makaslı Platformlar**
Table Truck

■ **Açılı Makaslı Platformlar**
Lift and Tilt Table

■ **Elektrikli U Form Platformlar**
Electric Table Truck U Form

■ **Elektrikli Makaslı Platformlar**
Electric Table Truck

■ **Motosiklet Platformları**
Service Lifter Platforms

PLATFORMLAR
TABLE TRUCKS

PASLANMAZ ÇELİK PLATFORM / STAINLESS LIFT TABLE

	NL-STT10	NL-STT20	
Kaldırma kapasitesi / Capacity	100	200	kg
Platform ölçüsü / Platform size	700x450	830x500	mm
Platform yüksekliği / Platform height	265-755	330-910	mm
El yüksekliği / Hand height	1000	1000	mm
Tekerlek Çapı / Wheel Dia.	ø100	ø125	mm
Toplam Boyut / Overall Size	450x950	500x1010	mm
Ayak Pedali / Foot Pedal	20	28	
Ağırlık / Net weight	40	78	kg

Art.No. 51500154

NL-STT10

Art.No. 51500155

NL-STT20

INOX



PLATFORM / TABLE TRUCK

	NL-TT 15	
Kaldırma kapasitesi / Capacity	150	kg
Min. tabla yüksekliği / Min. table height (h1)	220	mm
Max. tabla yüksekliği / Max. table height (h2)	720	mm
Tabla ölçüleri / The dimensions of table (lxbxd)	700 x 450 x 36	mm
Tekerlek ölçüsü / Caster wheel	100 x 25	mm
Maks. yükseklik için toplam pompalama / Foot pedal cycles to max. height	≈28	
Kol yüksekliği / Height of handle from the ground (h3)	950	mm
Ağırlık / Weight	46	kg

Art.No. 51500029

NL-TT 15

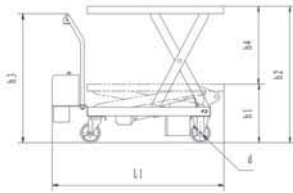

PLATFORM / TABLE TRUCK

	NL-TT 30	NL-TT 50	
Kaldırma kapasitesi / Capacity	300	500	kg
Min. tabla yüksekliği / Min. table height (h1)	285	285	mm
Max. tabla yüksekliği / Max. table height (h2)	880	880	mm
Tabla ölçüleri / The dimensions of table (lxbxd)	815 x 500 x 50	815 x 500 x 50	mm
Tekerlek ölçüsü / Caster wheel	125 x 40	125 x 40	mm
Maks. yükseklik için toplam pompalama / Foot pedal cycles to max. height	≈ 27	≈ 27	
Kol yüksekliği / Height of handle from the ground (h3)	990	990	mm
Ağırlık / Weight	77	81	kg

Art.No. 51500030

NL-TT 30

Art.No. 51500031

NL-TT 50

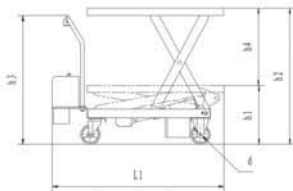

PLATFORM / TABLE TRUCK

NL-TTD 35

Art.No. 51500034

NL-TTD 35

Kaldırma kapasitesi / Capacity	350	kg
Min. tabla yüksekliği / Min. table height (h1)	355	mm
Max. tabla yüksekliği / Max. table height (h2)	1300	mm
Tabla ölçüleri / The dimensions of table (lxbxd)	910 x 500 x 53	mm
Tekerlek ölçüsü / Caster wheel	125 x 40	mm
Maks. yükseklik için toplam pompalama / Foot pedal cycles to max. height	< = 53	
Kol yüksekliği / Height of handle from the ground (h3)	975	mm
Ağırlık / Weight	105	kg

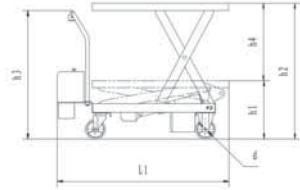

PLATFORM / TABLE TRUCK

NL-TTD 80

Art.No. 51500035

NL-TTD 80

Kaldırma kapasitesi / Capacity	800	kg
Min. tabla yüksekliği / Min. table height (h1)	445	mm
Max. tabla yüksekliği / Max. table height (h2)	1500	mm
Tabla ölçüleri / The dimensions of table (lxbxd)	1220 x 610	mm
Tekerlek ölçüsü / Caster wheel	125 x 40	mm
Maks. yükseklik için toplam pompalama / Foot pedal cycles to max. height	< = 97	
Kol yüksekliği / Height of handle from the ground (h3)	1015	mm
Ağırlık / Weight	195	kg

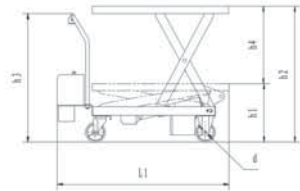

PLATFORM / TABLE TRUCK

NL-TTX 50

NL-TTX 100

Art.No. 51500036

NL-TTX 50

Art.No. 51500037

NL-TTX 100

Kaldırma kapasitesi / Capacity	500	1000	kg
Min. tabla yüksekliği / Min. table height (h1)	290	360	mm
Max. tabla yüksekliği / Max. table height (h2)	915	1360	mm
Tabla ölçüleri / The dimensions of table (lxbxd)	1600 x 810	2035 x 750	mm
Tekerlek ölçüsü / Caster wheel	125 x 40	180x50/ 80x40	mm
Maks. yükseklik için toplam pompalama / Foot pedal cycles to max. height	< = 55	< = 200	
Kol yüksekliği / Height of handle from the ground (h3)	975	1000	mm
Ağırlık / Weight	154	333	kg

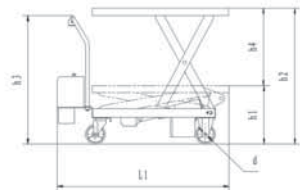

PLATFORM / TABLE TRUCK

	NL-TT 75	NL-TT 100	
Kaldırma kapasitesi / Capacity	750	1000	kg
Min. tabla yüksekliği / Min. table height	420	380	mm
Max. tabla yüksekliği / Max. table height	990	990	mm
Tabla ölçüleri / The dimensions of table	1000 x 510 x 55	1016 x 510 x 55	mm
Tekerlek ölçüsü / Caster wheel	147 x 50	125 x 50	mm
Maks. yükseklik için toplam pompalama / Foot pedal cycles to max. height	< = 45	< = 82	
Kol yüksekliği / Height of handle from the ground	990	980	mm
Ağırlık / Weight	125	140	kg

Art.No. 51500032

NL-TT 75

Art.No. 51500033

NL-TT 100



PLATFORM Akülü / ELECTRIC TABLE TRUCK

	NL-BTT 50	
Kaldırma kapasitesi / Capacity	500	kg
Min. tabla yüksekliği / Min. table height	440	mm
Max. tabla yüksekliği / Max. table height	1025	mm
Tabla ölçüleri / The dimensions of table	1010 x 520 x 50	mm
Tekerlek ölçüsü / Caster wheel	150 x 48	mm
Makine uzunluğu / Overall length	1305	mm
Kol yüksekliği / Height of handle from the ground	970	mm
Kaldırma hızı / Lifting speed (yükli/yüksüz, with/without load)	65/ 94	mm/s
İniş hızı / Lowering speed (yükli/yüksüz, with/without load)	98/ 74	mm/s
Dolu aküde kaldırma sayısı / Lifting cycle (full şarj, fully charged)	100	
Akü / Battery	2 x 12/ 24	V/Ah
Dikey hareket / Vertical travel	585	mm
Kaldırma motoru / Lifting motor (DC24V)	0.8	kw
Dahili şarj cihazı / Charger (built-in)	24 V 3A	
Kaldırma hızı / Approx. lifting speed	10	s
Net ağırlık / Net weight	157	kg

Art.No. 51500038

NL-BTT 50



PLATFORM Akülü / ELECTRIC TABLE TRUCK

	NL-BTT 75	
Kaldırma kapasitesi / Capacity	750	kg
Min. tabla yüksekliği / Min. table height	420	mm
Max. tabla yüksekliği / Max. table height	970	mm
Tabla ölçüleri / The dimensions of table	1000 x 510 x 55	mm
Tekerlek ölçüsü / Caster wheel	147 x 50	mm
Makine uzunluğu / Overall length	1345	mm
Kol yüksekliği / Height of handle from the ground	935	mm
Kaldırma hızı / Lifting speed (yükli/yüksüz, with/without load)	70/ 80	mm/s
İniş hızı / Lowering speed (yükli/yüksüz, with/without load)	50/ 35	mm/s
Dolu aküde kaldırma sayısı / Lifting cycle (full şarj, fully charged)	100	
Akü / Battery	2 x 12/ 15	V/Ah
Dikey hareket / Vertical travel	550	mm
Kaldırma motoru / Lifting motor (DC24V)	0.8	kw
Dahili şarj cihazı / Charger (built-in)	24V 3A	
Kaldırma hızı / Approx. lifting speed	12	s
Net ağırlık / Net weight	160	kg

Art.No. 51500072

NL-BTT 75



PLATFORM Akülü / ELECTRIC TABLE TRUCK

NL-BTTD 35

Art.No. 51500073

NL-BTTD 35

Kaldırma kapasitesi / Capacity	350	kg
Min. tabla yüksekliği / Min. table height	370	mm
Max. tabla yüksekliği / Max. table height	1300	mm
Tabla ölçüleri / The dimensions of table	910 x 500 x 53	mm
Tekerlek ölçüsü / Caster wheel	125 x 40	mm
Makine uzunluğu / Overall length	1210	mm
Kol yüksekliği / Height of handle from the ground	920	mm
Kaldırma hızı / Lifting speed (yükü/yüksüz, with/without load)	90/110	mm/s
İniş hızı / Lowering speed (yükü/yüksüz, with/without load)	100/90	mm/s
Dolu aküde kaldırma sayısı / Lifting cycle (fuli şarj, fully charged)	100	
Akü / Battery	2 x 12 / 24	V/Ah
Dikey hareket / Vertical travel	930	mm
Kaldırma motoru / Lifting motor (DC24V)	0.8	kw
Dahili şarj cihazı / Charger (built-in)	24 V 3A	
Kaldırma hızı / Approx. lifting speed	12	s
Net ağırlık / Net weight	142	kg



PLATFORMLAR
Table Trucks

AÇILI MAKASLI PLATFORM / LIFT & TILT TABLE

NL-TTA 15

NL-TTA 40

NL-TTA 80

Art.No. 51500039

NL-TTA 15

Art.No. 51500040

NL-TTA 40

Art.No. 51500041

NL-TTA 80

Kaldırma kapasitesi / Capacity	150	400	800	kg
Tabla ölçüleri UxG / Table size TxW (l x b)	830 x 500	830 x 520	830 x 520	mm
M ölçüsü / Dimensions M	830	830	930	mm
N ölçüsü / Dimensions N	748	830	830	mm
H1 Tabla yüksekliği / Table height H1 (min/max)	415/ 880	435/ 900	440/ 1000	mm
H2 Tabla yüksekliği / Table height H2 (min/max)	415/ 1400	435/ 1560	438/ 1570	mm
H3 Kol yüksekliği / Handle height H3 (min/max)	1100	1130	1130	mm
Teker çapı / Wheel diameter	125	150	150	mm
Toplam ölçüler / Overall Size	500 x 1010	520 x 1355	520 x 1355	mm
Maks. yüks. için pompalama / Foot pedal to max. height	20	55	80	
Net ağırlık / Net weight	92	123	145	kg

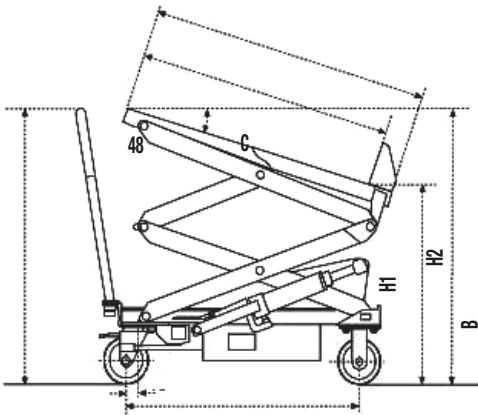

KONVEYÖR MAKASLI PLATFORM / CONVEYOR TRUCK

	NL-TTR 30	NL-TTR 50	
Kapasite / Capacity	300	500	kg
Min. yükseklik / Min. height	390	475	mm
Kaldırma yüksekliği / Lifting height	990	1000	mm
Merdane çapı / Dia. of the roller	55	55	mm
Merdane adedi / Quantity of the rollers	8		adet
Merdane arası mesafe / Space between the rollers	105	105	mm
Platform ölçüsü / Platform size	840 x 510	810 x 510	mm
Ağırlık / Weight	95	150	kg

Art.No. 51500042	NL-TTR 30
Art.No. 51500043	NL-TTR 50



PLATFORM Elektrikli / ELECTRIC TABLE TRUCK

	NL-TTF 1.0	NL-TTF 2.0	NL-TTF 4.0	NL-TTF 6.0	
Kaldırma kapasitesi / Capacity	500	1000	2000	3000	kg
Min. tabla yüksekliği / Min. table height (h ₁)	190	190	190	220	mm
Max. tabla yüksekliği / Max. table height (h ₂)	1010	1010	1010	1020	mm
Platform ölçüsü / Platform size (l x b)	1300 x 800	1300 x 800	1300 x 800	1300x800	mm
Kaldırma süresi / Lifting time	15	25	40	26	s
Kaldırma hızı / Lifting speed (yükli, with load)	55	40	22	30	mm/s
İniş hızı / Lowering speed (yükli, with load)	40	35	33	40	mm/s
Motor / Motor	0.75	0.75	0.75	1.5	kw
Voltaj / Voltage	380	380	380	380	V
Ağırlık / Weight	160	220	280	320	kg

Art.No. 51500044	NL-TTF 1.0
Art.No. 51500045	NL-TTF 2.0
Art.No. 51500046	NL-TTF 4.0
Art.No. 51500047	NL-TTF 6.0

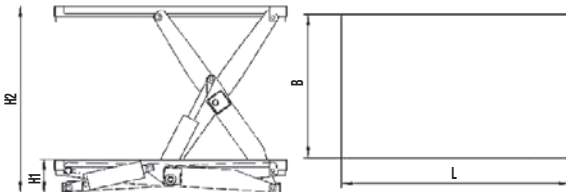

PLATFORM Elektrikli / ELECTRIC TABLE TRUCK

NL-TTG

Art.No. 51500049

NL-TTG

Kaldırma kapasitesi / Capacity	1000	kg
Min. tabla yüksekliği / Min. table height	82	mm
Max. tabla yüksekliği / Max. table height	760	mm
Platform ölçüsü / Platform size	1450 x 1140	mm
Kaldırma süresi / Lifting time	18	s
Kaldırma hızı / Lifting speed (yükli, with load)	42	mm/s
İniş hızı / Lowering speed (yükli, with load)	48	mm/s
Motor / Motor	0.75	kw
Voltaj / Voltage	380	V
Ağırlık / Net weight	250	kg



PLATFORMLAR
Table Trucks

PLATFORM Elektrikli U FORM / ELECTRIC TABLE TRUCK U FORM

NL-TTU

Art.No. 51500050

NL-TTU

Kaldırma kapasitesi / Capacity	1000	kg
Min. tabla yüksekliği / Min. table height (h ₁)	80	mm
Max. tabla yüksekliği / Max. table height (h ₂)	760	mm
Platform ölçüsü / Platform size (L x B)	1450 x 1140	mm
Platform ölçüsü / Platform size (B2)	585	mm
Kaldırma süresi / Lifting time	18	s
Kaldırma hızı / Lifting speed (yükli, with load)	42	mm/s
İniş hızı / Lowering speed (yükli, with load)	48	mm/s
Motor / Motor	0.75	kw
Voltaj / Voltage	380	V
Ağırlık / Net weight	235	kg

- Uzaktan kumanda güç kontrol sistemi sayesinde kontrol ve bakım kolaylığı.
- Elektronik kontrol kutusu - acil stop butonu.
- U dizayn platform ile palet ve sandık yüklemek için ideal.
- Remote power system, easy for controlling convenient for maintenance.
- Electronic control box with up, down and emergency buttons.
- Specially designed in "u" shape for handling pallets and boxes.

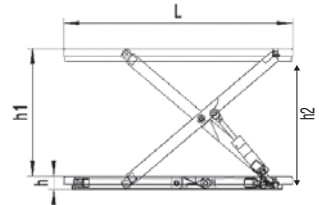
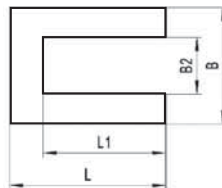

NL-TTDH Serisi



NL-TTH Serisi



NL-TTT Serisi



Art. No	Model	Kapasite / Capacity (kg)	Kapalı yükseklik / Lowered height (mm)	Açık yükseklik / Raised height (mm)	Platform ölçüsü / Platform size (mm)	Alt tabla ölçüsü / Base frame size (mm)	Kaldırma süresi / Lifting time (s)	Güç Ünitesi / Power pack	Ağırlık / Weight (kg)
51500074	NL- TTH 1001	1000	205	990	820x1300	640x1240	20-25	380V / 50HZ. AC1.1KW	160
51500075	NL- TTH 1002	1000	205	990	1000x1600	640x1240	20-25	380V / 50HZ. AC1.1KW	186
51500076	NL- TTH 1003	1000	240	1300	850x1700	640x1580	30-35	380V / 50HZ. AC1.1KW	200
51500077	NL- TTH 1004	1000	240	1300	1000x1700	640x1580	30-35	380V / 50HZ. AC1.1KW	210
51500078	NL- TTH 1005	1000	240	1300	850x2000	640x1580	30-35	380V / 50HZ. AC1.1KW	212
51500079	NL- TTH 1006	1000	240	1300	1000x2000	640x1580	30-35	380V / 50HZ. AC1.1KW	223
51500080	NL- TTH 2001	2000	230	1000	850x1300	785x1220	20-25	380V / 50HZ. AC2.2KW	235
51500081	NL- TTH 2002	2000	230	1000	1000x1600	785x1220	20-25	380V / 50HZ. AC2.2KW	268
51500082	NL- TTH 2003	2000	250	1300	850x1700	785x1600	25-35	380V / 50HZ. AC2.2KW	289
51500083	NL- TTH 2004	2000	250	1300	1000x1700	785x1600	25-35	380V / 50HZ. AC2.2KW	300
51500084	NL- TTH 2005	2000	250	1300	850x2000	785x1600	25-35	380V / 50HZ. AC2.2KW	300
51500085	NL- TTH 2006	2000	250	1300	1000x2000	785x1600	25-35	380V / 50HZ. AC2.2KW	315
51500086	NL- TTH 4001	4000	240	1050	1200x1700	900x1600	30-40	380V / 50HZ. AC2.2KW	375
51500087	NL- TTH 4002	4000	240	1050	1200x2000	900x1600	30-40	380V / 50HZ. AC2.2KW	405
51500088	NL- TTH 4003	4000	300	1400	1000x2000	900x2000	45-50	380V / 50HZ. AC2.2KW	470
51500089	NL- TTH 4004	4000	300	1400	1200x2000	900x2000	45-50	380V / 50HZ. AC2.2KW	490
51500090	NL- TTH 4005	4000	300	1400	1000x2200	900x2000	45-50	380V / 50HZ. AC2.2KW	480
51500091	NL- TTH 4006	4000	300	1400	1200x2200	900x2000	45-50	380V / 50HZ. AC2.2KW	505
51500125	NL- TTH 4007	4000	350	1780	1700x1500	640x1240	35-45	380V / 50HZ. AC2.2KW	510
51500126	NL- TTH 4008	4000	350	1300	1700x1500	1620x1400	35-45	380V / 50HZ. AC2.2KW	570
51500092-1	NL- TTDH 1000	1000	305	1785	820x1300	735x1240	35-45	380V / 50HZ. AC2.2KW	655
51500093	NL- TTDH 2000	2000	360	1780	850x1300	785x1220	35-45	380V / 50HZ. AC2.2KW	595
51500127	NL- TTDH 4000	4000	400	2050	1700x1200	1600x900	55-65	380V / 50HZ. AC2.2KW	520
51500048	NL-TTT 1.0	1000	470	3000	1700x1000	1600x1000	35-45	380V / 50HZ. AC2.2KW	450
51500053	NL-TTT 2.0	2000	560	3000	1700x1000	1606x1010	50-60	380V / 50HZ. AC2.2KW	750

Ağır Hizmet Tasarımı

TTH serisi Çalışma Platformu AB normlarını ve ANSI/ASME emniyet standartlarını karşılamaktadır. Bu modeller zemin altı ve zemin üstü kanal uygulamalarında kullanılabilir.

Standart Emniyet Özellikleri

Üst platform, kaldırma esnasında bir engelle temas ettğinde düşmesini önlemek amacıyla, alüminyum emniyet barı ile birlikte kaldırır. Düşük voltaj (24 V) Kumanda kutusu, aşağı-yukarı butonu ile. Aşırı yüklenmelere karşı emniyet vanası ve kontrollü indirme hız ayarı için kompanse akış vanalı dahili güç paketi. Drenaj sistemli ve hortum patlaması durumunda tablanın düşüşünü engelleyen kontrol vanalı ağır hizmet silindirlere. Çalışma esnasında sıkışmaya engel olacak şekilde makaslar arasında emniyet mesafesi.

Diğer Standart Özellikler

Pimli bağlantılarda kendinden yağlama yatakları.
Taşımayı ve tabla montajını kolaylaştıran çıkarılabilir kaldırma gözü.
Yüksek kaliteli AC güç paketleri Avrupa'da yapılmaktadır.

Heavy Duty Design

TTH series lift tables meet EN norm and ANSI/ASME safety standards. These models can be used for above-floor or in-floor pit applications.

Standart of Safety Features

Upper platform lifted with aluminum safety bar preventing descent on contact with obstructions. Low-Tension (24V) control box with up-down buttons. Internal power pack equipped with relief valve against overloading and compensated flow valve for controlled lowering speed. Heavy duty cylinders with drainage system and check valve to stop the lift table lowering in case of hose burst. Safety clearance between scissors to prevent trapping during operation.

Other Standard Features

Self lubricating bushings on pivot points.
Removable lifting eye to facilitate handling and lift table installation.
High quality AC power packs are made in Europe.

PLATFORM KÖRÜĞÜ / PROTECTION BELLOW

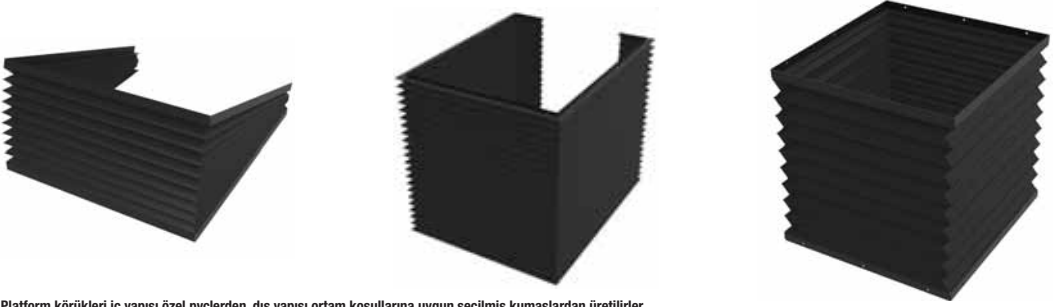

- Platform körükleri iç yapısı özel pvc'lerden, dış yapısı ortam koşullarına uygun seçilmiş kumaşlardan üretilirler.
- Yapısal olarak akordeon şeklinde oldukları için, kaldırma liftleri, gıda asansör grupları, engelli asansörleri, bant asansörleri gibi alanlarla kullanılırlar.
- Genel amaçları iş güvenliği kurallarına uygun ortam sağlamak ve platformun iç kısmı korozyon ve toz gibi dış etkenlere karşı korumaktır.
- Platform körükleri kare, dikdörtgen veya tek tarafı açık "U" şeklinde üretilirler. Dikey veya açılabilir olarak çalışabilirler.

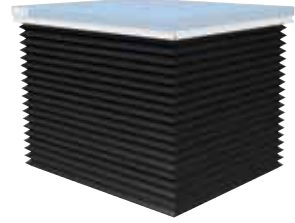

Art.No	Model
51510074	NL-TTH-1001 K
51510075	NL-TTH-1002 K
51510076	NL-TTH-1003 K
51510077	NL-TTH-1004 K
51510078	NL-TTH-1005 K
51510079	NL-TTH-1006 K
51510080	NL-TTH-2001 K
51510081	NL-TTH-2002 K
51510082	NL-TTH-2003 K
51510083	NL-TTH-2004 K
51510084	NL-TTH-2005 K
51510085	NL-TTH-2006 K
51510086	NL-TTH-4001 K
51510087	NL-TTH-4002 K
51510088	NL-TTH-4003 K
51510089	NL-TTH-4004 K
51510090	NL-TTH-4005 K
51510091	NL-TTH-4006 K
51510125	NL-TTH-4007 K
51510126	NL-TTH-4008 K
51510044	NL-TTF 1.0 K
51510045	NL-TTF 2.0 K
51510046	NL-TTF 4.0 K
51510047	NL-TTF 6.0 K
51510049	NL-TTG K
51510050	NL-TTU K



TTH SERİSİ

TTDH SERİSİ

TTT SERİSİ

TTU SERİSİ

PLATFORM RAMPASI / TABLE TRUCK RAMP

Art. No. / Art. No.		51520049	
Model / Model		*RP 1	
Kapasite / Capacity		1	t
Maks. yükseklik / Max. yükseklik	H	90	mm
Genişlik / Width	M	1140	mm
Uzunluk / Length	L	900	mm
Ağırlık / Weight		39	kg

*RP 1 model Platform Rampası TTG ve TTU model platformlar için uygundur.

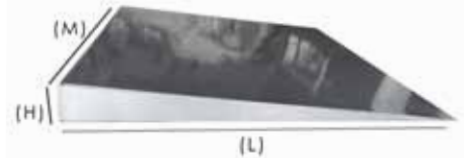

ENDÜSTRİYEL UZAKTAN KUMANDA

INDUSTRIAL REMOTE CONTROL

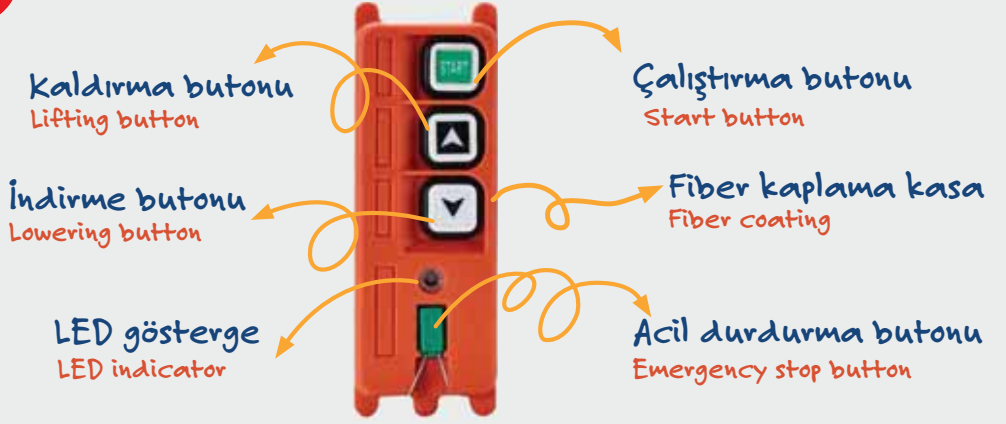

- 5A anahtarlama kontakları
- Manyetik emniyet anahtarı
- LED uyarı sistemi (pil, bağlantı kesilmesi, arıza)
- Kolay taşınabilir mini el ünitesi
- AC / DC uygulaması
- 5A switching contacts
- Magnetic safety switch
- LED warning system (battery, disconnection, malfunction)
- Easy to carry mini hand unit
- AC / DC application

Kontrol mesafesi / Control reach area	100 m (açık alanda / outdoor)
Kumanda hareketi / Command button	2
Osilatör tipi / Oscillator type	Kristal / Crystal
Kasa yapısı / Case material	Fiber / Fiber
Çalışma frekansı / Operation frequency	310.0325 - 331.165 MHz
Şifreleme kodu / Coding type	> 4.3k
Çalışma ortamı sıcaklığı / Working temperature	-35 +80°C
IP sınıfı / IP class	IP65 (alıcı ve verici üniteleri / Receiver & transmitter units)
Çalışma gerilimi / Operation voltage	24 / 48 / 110 / 220 / 380 V AC / DC



DARBEYE DAYANIKLI KOMPAKT ALICI ÜNİTESİ

COMPACT RECEIVER UNIT WITH IMPACT RESISTANT



ERGONOMİK VE SAĞLAM EL KUMANDASI

ERGONOMIC AND STRONG HAND CONTROLLER



KRİSTAL OSİLATÖRLÜ, ŞİFRELİ VERİCİ

ENCRYPTED TRANSMITTER WITH CRYSTAL OSCILLATOR



SANAYİDE FARKLI ALANLARA UYURLANABİLME

ADAPTABLE TO DIFFERENT APPLICATIONS IN THE INDUSTRY



FARKLI MAKİNELERE VE VOLTAJLARA ADAPTE EDİLEBİLME

ADAPTABLE TO DIFFERENT MACHINES AND VOLTAGES



FARKLI ALANLARDA 100m ERİŞİM MESAFESİ

REACH DISTANCE UP TO 100m IN DIFFERENT APPLICATIONS

HİDROLİK MOTOSİKLET SERVİS LİFTİ / HYDRAULIC MOTORCYCLE SERVICE LIFTER

NL-TC 150

Art.No. 51500051

NL-TC 150

Kaldırma kapasitesi / Capacity	150 kg
Max. platform yüksekliği / Max. platform height	1070 mm
Min. platform yüksekliği / Min. platform height	145 mm
Platform ölçüleri / Platform size	1400 x 470 mm
Maks.yükseklik için pompa sayısı / Foot pedal to max. height	40
Net ağırlık / Net weight	100 kg

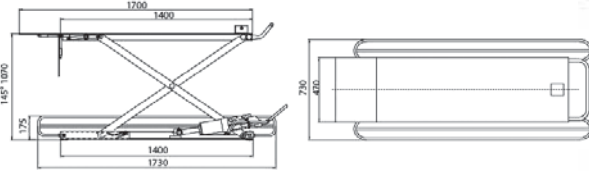

HİDROLİK MOTOSİKLET SERVİS LİFTİ / HYDRAULIC MOTORCYCLE SERVICE LIFTER

NL-TC 500

Art.No. 51500052

NL-TC 500

Kaldırma kapasitesi / Capacity	500 kg
Max. platform yüksekliği / Max. platform height	800 mm
Min. platform yüksekliği / Min. platform height	170 mm
Platform ölçüleri / Platform size	2200 x 700 mm
Net ağırlık / Net weight	235 kg

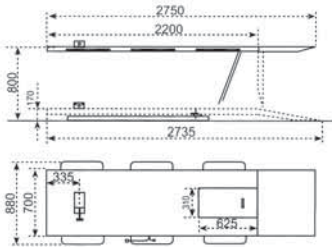

HİDROLİK MOTOSİKLET SERVİS LİFTİ / HYDRAULIC MOTORCYCLE SERVICE LIFTER

NL-TE 500

Art.No. 51500054

NL-TE 500

Kaldırma kapasitesi / Capacity	500 kg
Max. platform yüksekliği / Max. platform height	800 mm
Min. platform yüksekliği / Min. platform height	170 mm
Platform ölçüleri / Platform size	2200 x 700 mm
Kaldırma süresi / Lifting time	8/15 s
Güç ünitesi / Power pack	380V/ 50Hz, AC 1.1 kw
Net ağırlık / Net weight	240 kg

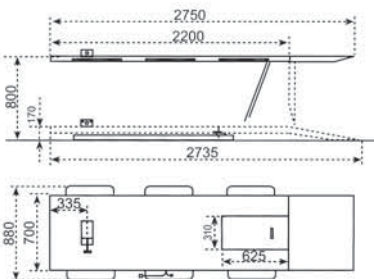



100 TON'A KADAR MALZEMELERİ İTMEK - ÇEKMEK - YÖNLENDİRMEK ARTIK ÇOK KOLAY



Elektrik veya hava tahrikli bu minik araç; uçak, helikopter gibi hava araçlarını park sahalarına yerleştirmek, çelik, kağıt, kablo, halat rulolarını itmek, otomotiv sanayiinde imalat veya bakım sürecindeki kamyon, otobüs ve iş makinalarını itmek için ideal bir üründür.



C1500A



CF1500A



V1250B



NET MAK
METAL MAKİNA SANAYİ VE TİCARET LTD. ŞTİ.