



■ **Polyester Sonsuz Halatlar**  
*Polyester Round Slings*

■ **Polyester Sapanlar**  
*Polyester Webbing Slings*

■ **Zincir Sapanlar**  
*Chain Slings*

■ **Kancalar**  
*Hooks*

■ **Mapalar**  
*Eye Bolts*

**SAPANLAR ve AKSESUARLARI**  
**SLINGS AND ACCESSORIES**

**POLYESTER SONSUZ HALAT (SF 7:1) / POLYESTER ROUND SLING**

Düz kaldırma kapasitesi/ Straight lifting capacity (WLL)	Sonsuz Halat Uzunlukları/ Length of round sling (L1) m						
	2m	3m	4m	5m	6m	8m	
<b>1.000 kg</b>	Art.No. 56510102	56510103	56510104	56510105	56510106	56510108	
<b>2.000 kg</b>	Art.No. 56510202	56510203	56510204	56510205	56510206	56510208	
<b>3.000 kg</b>	Art.No. 56510302	56510303	56510304	56510305	56510306	56510308	
<b>4.000 kg</b>	Art.No. 56510402	56510403	56510404	56510405	56510406	56510408	
<b>5.000 kg</b>	Art.No. 56510502	56510503	56510504	56510505	56510506	56510508	
<b>6.000 kg</b>	Art.No. 56510602	56510603	56510604	56510605	56510606	56510608	
<b>8.000 kg</b>	Art.No. 56510802	56510803	56510804	56510805	56510806	56510808	
<b>10.000 kg</b>	Art.No. 56511002	56511003	56511004	56511005	56511006	56511008	

**Emniyet faktörü: 7:1**  
Safety factor: 7:1

\* Farklı ölçüler için satış temsilcilerimizle iletişime geçiniz.

\* Please contact our sales department for different capacities.

SONSUZ HALATLAR - KAPASİTESİ TABLOSU (kg)							
Renk Kodu	Düz kaldırma	Boğma	U kaldırma	Açılı kaldırılmalar			
				0° - 45°	45° - 60°	0° - 45°	45° - 60°
	500	400	1000	700	500	350	250
	1000	800	2000	1400	1000	700	500
	2000	1600	4000	2800	2000	1400	1000
	3000	2400	6000	4200	3000	2100	1500
	4000	3200	8000	5600	4000	2800	2000
	5000	4000	10000	7000	5000	3500	2500
	6000	4800	12000	8400	6000	4200	3000
	8000	6400	16000	11200	8000	5600	4000
	10000	8000	20000	14000	10000	7000	5000

SF7 / EN 1492-2

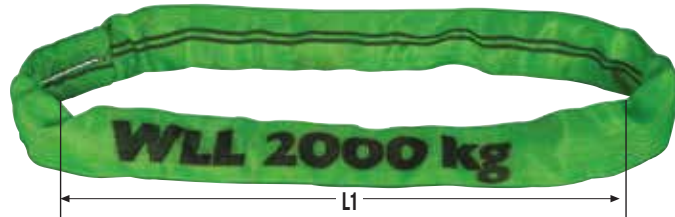

- EN 1492-2 ve Makine Emniyet Yönetmeliği 2006/ 42 EC' ye göre üretilmiştir.
- Sonsuz halatlar bükülmüş polyester elyafın özel bir teknikle birleştirilmesi yolu ile imal edilmekte olup, elyafın üzeri yine polyesterden mamul dokuma bir kılıf ile korunmaktadır.
- Polyester sonsuz halatlar yumuşak dokulu özelliklerinden dolayı kaldırılacak malzemenin şeklini alır ve esnek yapıları nedeni ile kullanım kolaylığı sağlar.
- Manufactured according to EU Machinery Directive 2006/ 42 EC and EN 1492-2
- The carrying element of a PES roundsling are endlessly haid, high quality polyester fibre yarns which protected by a coat of seamless wovnen and impregnated polyester web.
- The use of roundslings contains many advantages like high working load limits with low own-Weights, good adaptability to the goods, pleasand handling without problems etc.



## POLYESTER SAPAN (SF 7:1) / POLYESTER WEBBING SLING (SF 7:1)

Düz kaldırma kapasitesi/ Straight lifting capacity (WLL)	Polyester Sapan Uzunlukları/ Length of polyester sling (L1) m						
	2m	3m	4m	5m	6m	8m	10m
1.000 kg	Art.No. 56710102	56710103	56710104	56710105	56710106	56710108	56710110
2.000 kg	Art.No. 56710202	56710203	56710204	56710205	56710206	56710208	56710210
3.000 kg	Art.No. 56710302	56710303	56710304	56710305	56710306	56710308	56710310
4.000 kg	Art.No. 56710402	56710403	56710404	56710405	56710406	56710408	56710410
5.000 kg	Art.No. 56710502	56710503	56710504	56710505	56710506	56710508	56710510
6.000 kg	Art.No. 56710602	56710603	56710604	56710605	56710606	56710608	56710610
8.000 kg	Art.No. 56710802	56710803	56710804	56710805	56710806	56710808	56710810
10.000 kg	Art.No. 56711002	56711003	56711004	56711005	56711006	56711008	56711010

GÖZLÜ SAPAN - KAPASİTESİ TABLOSU (kg)					
Renk kodu	Düz kaldırma	Boğma	U kaldırma	Açılı kaldırma	
				0° - 45°	45° - 60°
	500	400	1000	700	500
	1000	800	2000	1400	1000
	2000	1600	4000	2800	2000
	3000	2400	6000	4200	3000
	4000	3200	8000	5600	4000
	5000	4000	10000	7000	5000
	6000	4800	12000	8400	6000
	8000	6400	16000	11200	8000
	10000	8000	20000	14000	10000

**Emniyet faktörü: 7:1**  
Safety factor: 7:1

\* Farklı ölçüler için satış temsilcilerimizle irtibata geçiniz.

\* Please contact our sales department for different capacities.

- Ağır hizmet polyester bant
- Dayanıklı ve uzun ömürlü göz koruyucuları
- Uluslararası renk kodları
- Optimize edilmiş esneklik
- Yüksek emniyet katsayısı

- Heavy duty polyester band
- High stability and long life eye protectors
- International color codes
- Optimized flexibility
- High rated safety coefficient



**TEK KULLANIMLIK POLYESTER SONSUZ BANT (SF 1:5) / ONE USE WEBBING SLING (SF 1:5)**



Tek kullanımlık dokuma sonsuz sapanlar DIN 60005'e göre üretilmektedir ve 1:5 emniyet faktörüne sahiplerdir. Bu yük taşıma kapasitesi 1 ton olan bir sapanın kopma mukavemetinin 5 ton olması gerektiği anlamına gelir. Taşıma zincirinin sonunda tekrar kullanılmayıp atılmaları gereklidir. Tek kullanımlık veya atılabilir dokuma sapanlar pratik uygulamalarda değişik renklerde dokuma sonsuz sapan veya gözlü sapan gibi çok farklı tasarımlara sahip olabilirler.

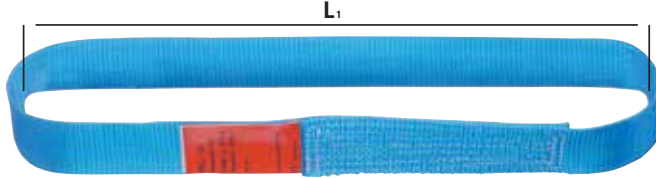

Art.No.	Kaldırma Kapasitesi WLL (t)	Bant uzunlukları L1 (m)
15411517	1.5	1.50
15411516	1.5	1
15411015	1	1.5
15411010	1	1
15412075	2	0.75
15412090	2	0.90
15412018	2	1.80

Fiyatlar stoktaki ürünler için geçerlidir.

**GERDİRMELER / CARGO LASHINGS**

Kapasitesi / Capacity	NL-35-4			NL-35-6			NL-35-8			NL-50-8			NL-50-10			NL-50-12			daN
	1000/ 2000						2000/ 4000												
Bant genişliği / Band width	35	35	35	50	50	50	50	50	50	50	50	50	50	50	50	50	50	50	mm
Uzunluk / Length	4	6	8	8	10	12	8	10	12	8	10	12	8	10	12	8	10	12	m

Art.No. 52000109	NL-35-4
Art.No. 52000110	NL-35-6
Art.No. 52000111	NL-35-8
Art.No. 52000112	NL-50-8
Art.No. 52000113	NL-50-10
Art.No. 52000114	NL-50-12

- Uzun ömürlü
- Sağlam mekanizma
- Farklı bant genişliği ve farklı kanca çeşitleri
- Tüm gerdirmeler PES, DIN 60060 VDI 2700, 2701, 2702 prEN 12195-2 standartlarında üretilmiştir.
- Yukarıda verilen uzunluklar standart uzunluklardır. Ancak isteğinize bağlı olarak uzunluklar için bizimle iletişime geçiniz.
- Opsiyonel olarak mekanizma ve kancalar paslanmaz çelikten imal edilebilir.



- Long life-time
- Robust mechanism
- Different band width and hook types
- All ratchet tie downs has manufactured acc. PES, DIN 60060 VDI 2700, 2701, 2702 prEN 12195-2 standards.
- All above mentioned lengths are standard but any other length is possible.
- Ratchet and the hooks can be delivered in stainless steel version as option.

**PARKE SIKMA / ARCHITECTURAL TOOL**

		NL-TDRPS	
Boy / Length		5	m
Kapasite / Capacity		180	kg
Kanca / Hook		Metal birleştirici/ Metal plates	

Art.No. 52000107 NL-TDRPS



## ZİNCİR GERGİ MEKANİZMASI - ÇATAL + ÇATAL

Art.No	9380 16 01	9380 16 02	9380 16 03	9380 16 04	9380 16 05	
Zincir ölçüsü / Chain size	6	8	10	13	16	mm
Gerdirme kuvveti / Tensile strength	2200	4000	6300	10000	16000	daN
Kopma yükü / Breaking load	45.20	80.40	126.00	212.00	322.00	kN
Ayar aralığı (l) min./max / Adjustment range	230 - 320	330 - 470	460 - 670	520 - 770	540 - 790	mm
Gerdirme uzunluğu / Stretching length	90	140	220	250	250	mm
Kg / Weight	100	200	400	670	950	%

**Malzeme** : Yüksek mukavemetli alaşım çelik, Grade 80  
**Standart** : DIN EN 1677-1 'e göre üretici sertifikası  
DIN EN 12195-3' e göre sertifikalandırılmıştır.

**Material** : High tensile alloyed steel, Grade 8  
**Standard** : Acc.to DIN EN 1677-1 and  
DIN EN 12195-3

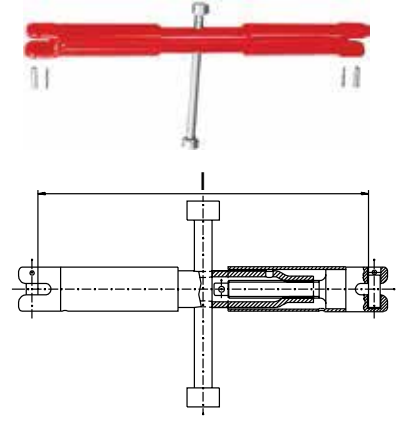

## ZİNCİR GERGİ MEKANİZMASI - GÖZ + GÖZ

Art.No	9380 18 01	9380 18 02	9380 18 03	9380 18 04	9380 18 05	
Zincir ölçüsü / Chain size	6	8	10	13	16	mm
Gerdirme kuvveti / Tensile strength	2200	4000	6300	10000	16000	daN
Kopma yükü / Breaking load	45.20	80.40	126.00	212.00	322.00	kN
Ayar aralığı (l) min./max / Adjustment range	412 - 502	588 - 738	630 - 780	722 - 872	784 - 914	mm
Gerdirme uzunluğu / Stretching length	90	150	150	150	130	mm
Kg / Weight	171	455	575	858	1334	%

**Malzeme** : Yüksek mukavemetli alaşım çelik, Grade 80  
**Standart** : DIN EN 1677-1 'e göre üretici sertifikası  
DIN EN 12195-3' e göre sertifikalandırılmıştır.

**Material** : High tensile alloyed steel, Grade 8  
**Standard** : Acc.to DIN EN 1677-1 and  
DIN EN 12195-3

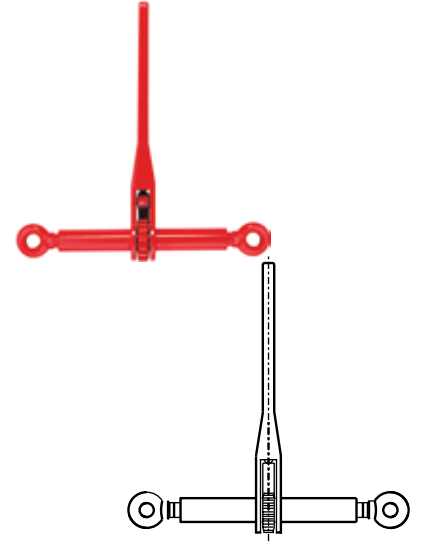

## ZİNCİR GERGİ MEKANİZMASI - KANCA + KANCA

Art.No	9380 18 11	9380 18 12	9380 18 13	9380 18 14	9380 18 15	
Zincir ölçüsü / Chain size	6	8	10	13	16	mm
Gerdirme kuvveti / Tensile strength	2200	4000	6300	10000	16000	daN
Kopma yükü / Breaking load	45.20	80.40	126.00	212.00	322.00	kN
Ayar aralığı (l) min./max / Adjustment range	232 - 322	360 - 510	360 - 510	366 - 516	390 - 520	mm
Gerdirme uzunluğu / Stretching length	90	150	150	150	130	mm
Kg / Weight	117	340	340	400	670	%

**Malzeme** : Yüksek mukavemetli alaşım çelik, Grade 80  
**Standart** : DIN EN 1677-1 'e göre üretici sertifikası  
DIN EN 12195-3' e göre sertifikalandırılmıştır.

**Material** : High tensile alloyed steel, Grade 8  
**Standard** : Acc.to DIN EN 1677-1 and  
DIN EN 12195-3

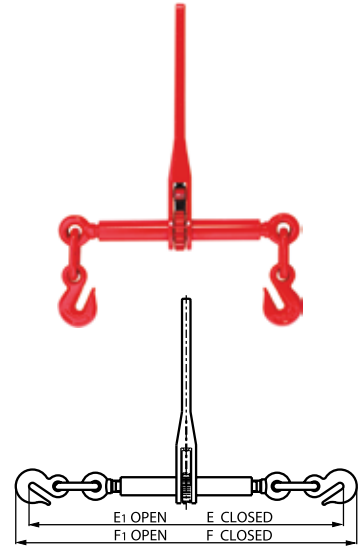

## KISALTMA KANCASIZ WITHOUT SHORTENING HOOK GRADE 8

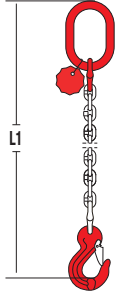

**TEK BACAKLI ZİNCİR SAPAN /**  
ONE LEGGED CHAIN SLING



W.L.L (kg)	Zincir Çapı Chain dia (mm)	Kod No Code no	Kod No Code no	Kod No Code no
1120	6	5891001	58910011	58910021
2000	8	5891003	58910013	58910023
3150	10	5891004	58910014	58910024
5300	13	5891005	58910015	58910025
8000	16	5891006	58910016	58910026

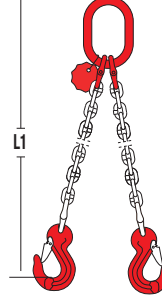

**İKİ BACAKLI ZİNCİR SAPAN /**  
TWO LEGGED CHAIN SLING



W.L.L (kg) 0 - 45°	W.L.L (kg) 45 - 60°	Zincir Çapı Chain dia (mm)	Kod No Code no	Kod No Code no	Kod No Code no
1600	1120	6	58910031	58910041	58910051
2800	2000	8	58910033	58910043	58910053
4250	3150	10	58910034	58910044	58910054
7500	5300	13	58910035	58910045	58910055
11200	8000	16	58910036	58910046	58910056

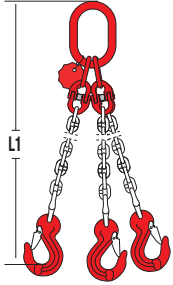

**ÜÇ BACAKLI ZİNCİR SAPAN /**  
THREE LEGGED CHAIN SLING



W.L.L (kg) 0 - 45°	W.L.L (kg) 45 - 60°	Zincir Çapı Chain dia (mm)	Kod No Code no	Kod No Code no	Kod No Code no
2360	1700	6	58910061	58910071	58910081
4250	3000	8	58910063	58910073	58910083
6700	4750	10	58910064	58910074	58910084
11200	8000	13	58910065	58910075	58910085
17000	11800	16	58910066	58910076	58910086

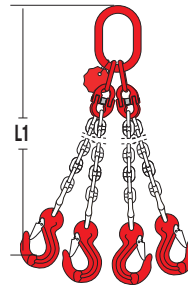

**DÖRT BACAKLI ZİNCİR SAPAN /**  
FOUR LEGGED CHAIN SLING



W.L.L (kg) 0 - 45°	W.L.L (kg) 45 - 60°	Zincir Çapı Chain dia (mm)	Kod No Code no	Kod No Code no	Kod No Code no
2360	1700	6	58910091	58910101	58910111
4250	3000	8	58910093	58910103	58910113
6700	4750	10	58910094	58910104	58910114
11200	8000	13	58910095	58910105	58910115
17000	11800	16	58910096	58910106	58910116

### ZİNCİR SAPAN KULLANIMINDA DİKKAT EDİLMESİ GEREKEN HUSUSLAR

Zincirlerin ve zincir sapanların, sürekli kullanımda ortaya çıkacak aşınmalara ve hasarlara karşı düzenli aralıklarla kontrol edilmesi, emniyetli kullanım için uygun olup olmadığının tespiti için gereklidir.

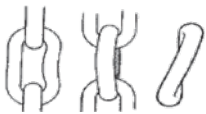

#### DEFORMASYON :

Eğilmiş, bükülmüş, aşırı sıcak nedeniyle deforme olmuş / korozyona uğramış zincirler derhal kullanımdan kaldırılmalıdır.



#### ÇATLAMALAR

Çatlama gösteren zincirler derhal atılmalıdır. Enine çatlamlar en ciddi durumdur.



#### TANIMLAMA ETİKETİ :

Üzerinde tanımlama etiketi bulunmayan zincir sapanlar kullanılmamalıdır.



#### KAYNAK

Üzerinde kaynak lemi yapılmış zincirler kullanılmamalıdır.

## KISALTMA KANCALI WITH SHORTENING HOOK GRADE 8



**KISALTMA KANCALI TEK BACAĞLI  
ZİNCİR SAPAN**  
WITH SHORTENING HOOK ONE LEGGED CHAIN SLING



W.L.L (kg)	Zincir Çapı Chain dia (mm)	Kod No Code no	Kod No Code no	Kod No Code no
1120	6	58910121	58910131	58910141
2000	8	58910123	58910133	58910143
3150	10	58910124	58910134	58910144
5300	13	58910125	58910135	58910145
8000	16	58910126	58910136	58910146

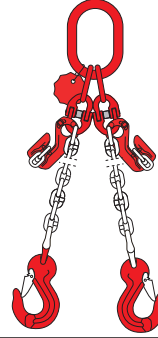

**KISALTMA KANCALI İKİ BACAĞLI  
ZİNCİR SAPAN**  
WITH SHORTENING HOOK TWO LEGGED CHAIN SLING



W.L.L (kg)	W.L.L (kg)	Zincir Çapı Chain dia (mm)	Kod No Code no	Kod No Code no	Kod No Code no
0 - 45°	45 - 60°				
1600	1120	6	58910151	58910161	58910171
2800	2000	8	58910153	58910163	58910173
4250	3150	10	58910154	58910164	58910174
7500	5300	13	58910155	58910165	58910175
11200	8000	16	58910156	58910166	58910176

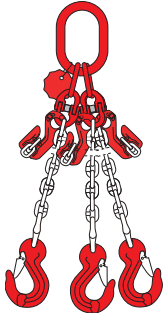

**KISALTMA KANCALI ÜÇ BACAĞLI  
ZİNCİR SAPAN**  
WITH SHORTENING HOOK THREE LEGGED CHAIN SLING



W.L.L (kg)	W.L.L (kg)	Zincir Çapı Chain dia (mm)	Kod No Code no	Kod No Code no	Kod No Code no
0 - 45°	45 - 60°				
2360	1700	6	58910181	58910191	58910201
4250	3000	8	58910183	58910193	58910203
6700	4750	10	58910184	58910194	58910204
11200	8000	13	58910185	58910195	58910205
17000	11800	16	58910186	58910196	58910206

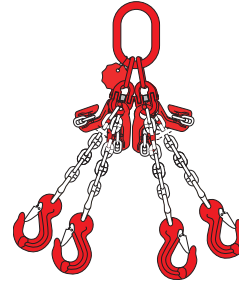

**KISALTMA KANCALI DÖRT BACAĞLI ZİNCİR SAPAN**  
WITH SHORTENING HOOK FOUR LEGGED CHAIN SLING



W.L.L (kg)	W.L.L (kg)	Zincir Çapı Chain dia (mm)	Kod No Code no	Kod No Code no	Kod No Code no
0 - 45°	45 - 60°				
2360	1700	6	58910211	58910221	58910231
4250	3000	8	58910213	58910223	58910233
6700	4750	10	58910214	58910224	58910234
11200	8000	13	58910215	58910225	58910235
17000	11800	16	58910216	58910226	58910236

### ZİNCİR SAPAN KULLANIMINDA DİKKAT EDİLMESİ GEREKEN HUSUSLAR

Kanca ve mapaların , sürekli kullanımda ortaya çıkacak aşınmalara ve hasarlara karşı düzenli aralıklarla kontrol edilmesi, emniyetli kullanım için uygun olup olmadığının tespiti için gereklidir.



Güvenlik mandallı kancalarda, güvenlik mandalı fonksiyonunu kaybetmişse kullanımdan çıkarılmalıdır.



Kancanın yük merkezindeki aşınma oranı %10 seviyesini aşmamalıdır.



Eğilme, bükülme durumunda kanca kullanımdan çıkarılmalıdır. Kimi kaynaklar 10° ye kadar olan eğilme ve bükülmeleri tolere edebilmektedir.

**Periyodik kontroller dışında, her kullanım öncesi kullanıcı kontrolü yapılmalıdır !**

**KAPASİTE TABLOSU / CAPACITY CHART GRADE 8**

Zincir çapı Chain Dia mm	İzin verilen kapasiteler / Permitted load-bearing capacity in t for:											
	Tek Bacak Single leg			İki Bacak Two leg		3 ve 4 Bacak 3 and 4-leg		Tek Bacak Basket Single leg Basket Sling		İki Bacak Basket Two leg Basket sling		Sonsuz Sapan Boğma Endless sling in choke
Kaldırma Açısı Angle of inclination β	0°	0° - 45°	45° - 60°	0° - 45°	45° - 60°	0° - 45°	45° - 60°	0° - 45°	45° - 60°	0° - 45°	45° - 60°	
6	1,12	1,6	1,12	2,36	1,7	1,18	0,85	1,9	1,32			1,8
8	2	2,8	2	4,25	3	2,12	1,6	3,35	2,36			3,15
10	3,15	4,25	3,15	6,7	4,75	3,35	2,5	5,3	3,75			5
13	5,3	7,5	5,3	11	8	5,6	4	9	6,3			8,5
16	8	11,2	8	17	11,8	8,5	6,3	13,2	9,5			12,5

**ZİNCİR / CHAIN GRADE 8**

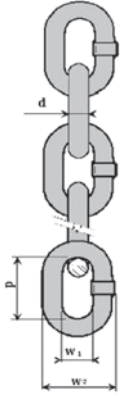

Model	Kod No Art. No.	Boyutlar / Dimensions (mm)				
		Zincir Çapı Chain size d	İç bakla uzunluğu Pitch p	Genişlik Width w 1min.	Genişlik Width w 2 max	Ağırlık Weight kg / m
NL-C 06	58900006	6	18	7,8	22,5	0,8
NL-C 08	58900008	8	24	10,4	29,6	1,4
NL-C 10	58900010	10	30	13,0	37,0	2,2
NL-C 13	58900013	13	39	16,9	48,1	3,8
NL-C 16	58900016	16	48	20,8	59,2	5,7

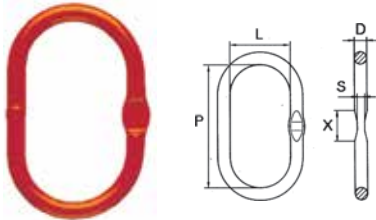

**ANA BAĞLANTI HALKASI / MASTERLINK**

**GRADE 8**

Kod No Art. No.	Model	Zincir / Chain		W.L.L. kg	Boyutlar / Dimensions mm				Ağırlık / Weight kg
		∅ mm	∧ mm		D	P	L	SxX	
58900106	NL-CM 06	7	6	1600	13	110	60	8x25	0.34
58900107	NL-CM 08	8	7	2120	16	110	60	8x25	0.53
58900108	NL-CM 10	10	8	3150	18	135	75	8x25	0.915
58900110	NL-CM 13	13	10	5300	22	160	90	11.3x35	1.60
58900113	NL-CM 16	16	13	8000	26	180	100	14x46	2.46

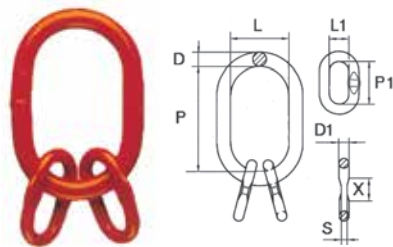

**ANA BAĞLANTI HALKASI / MASTERLINK WITH SUBLINKS**

**GRADE 8**

Kod No Art. No.	Model	Zincir / Chain ∅ mm	W.L.L. kg	Boyutlar / Dimensions mm								Ağırlık / Weight kg
				D	P	L	D1	P1	L1	SxX		
58900206	NL-CMC 06	6	2360	18	135	75	13	54	25	8x25	1.315	
58900208	NL-CMC 08	8	4250	22	160	90	16	70	34	8x25	2.32	
58900210	NL-CMC 10	10	6700	26	180	100	18	85	40	11.3x35	3.52	
58900213	NL-CMC 13	13	11200	32	200	110	22	115	50	14x46	6.26	
58900216	NL-CMC 16	16	17000	36	260	140	26	140	65	18x46	9.56	

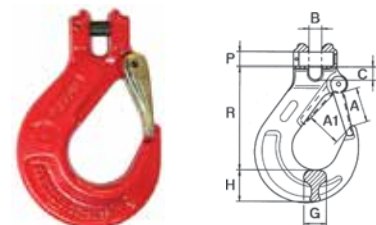

**EMNİYET MANDALLI KANCA / CLEVIS HOOK WITH LATCH**

**GRADE 8**

Kod No Art. No.	Model	Zincir / Chain		W.L.L. kg	Boyutlar / Dimensions mm										Ağırlık / Weight kg
		mm	inch		A	A1	B	C	G	H	P	R			
58900906	NL-CB 06	6	1/4	1120	25	19	6,7	8,5	14,5	20	7	73	0,24		
58900908	NL-CB 08	8	5/16	2000	29,5	24,5	8,7	9,8	19	27	9	86,3	0,53		
58900910	NL-CB 10	10	3/8	3150	35,7	29	12,2	13,5	23,5	33	13	105	0,95		
58900913	NL-CB 13	13	1/2	5300	43,5	35	15,3	17	28,5	40	16	128,5	1,67		
58900916	NL-CB 16	16	5/8	8000	56	45	18	22	37	48	20	155	3,00		

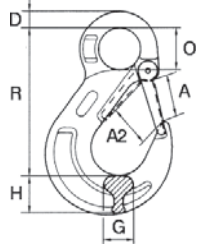

**EMNİYET MANDALLI KUŞ GÖZLÜ KANCA / SLING HOOK WITH LATCH****GRADE 8**

Kod No Art No.	Model	Zincir / Chain		W.L.L. kg	Boyutlar / Dimensions mm							Ağırlık / Weigh kg
		mm	inch		A	A2	D	G	H	O	R	
58900606	NL-CA 06	6	1/4	1120	25	20,5	8,5	14,5	20	20,5	80,5	0,27
58900608	NL-CA 08	8	5/16	2000	29,5	24,5	11	19	27	25	95,5	0,50
58900610	NL-CA 10	10	3/8	3150	35,7	29	14	23,5	33	34	120,5	0,90
58900613	NL-CA 13	13	1/2	5300	43,5	35,4	17,5	29	40	42,5	150	1,50
58900616	NL-CA 16	16	5/8	8000	52,5	44	22	35,5	49	52	183	2,75

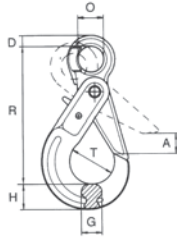
**GÖVDE MANDALLI KUŞ GÖZLÜ KANCA / SELF LOCKING EYE HOOK****GRADE 8**

Kod No Art No.	Model	Zincir / Chain		W.L.L. kg	Boyutlar / Dimensions mm							Ağırlık / Weigh kg
		mm	inch		A	D	G	H	O	R	T	
58900806	NL-CRO 06	6	1/4	1120	28	11	16	21	21	109	35	0,510
58900808	NL-CRO 08	8	5/16	2000	34	12	20	26	25	135	43	0,936
58900810	NL-CRO 10	10	3/8	3150	45	16	25	30	33	168	56	1,626
58900813	NL-CRO 13	13	1/2	5300	51	20	35	40	40	205	69	3,250
58900816	NL-CRO 16	16	5/8	8000	60	27	36	50	50	251	80	6,050

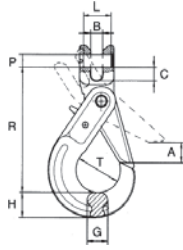
**GÖVDE MANDALLI KANCA / SELF LOCKING CLEVIS HOOK****GRADE 8**

Kod No Art No.	Model	Zincir / Chain		W.L.L. kg	Boyutlar / Dimensions mm										Ağırlık / Weigh kg
		mm	inch		A	B	C	G	H	R	T	PxL			
58900706	NL-CRF 06	6	1/4	1120	28	7	8	16	21	94	35	7,5x17,5	0,496		
58900708	NL-CRF 08	8	5/16	2000	34	9	10	20	26	123	43	9x22,5	0,934		
58900710	NL-CRF 10	10	3/8	3150	45	12	14	25	30	143	56	13,31,5	1,580		
58900713	NL-CRF 13	13	1/2	5300	51	15	17	35	40	180	69	16x42	3,200		
58900716	NL-CRF 16	16	5/8	8000	60	19	19	36	50	215	80	21x51x5	5,950		

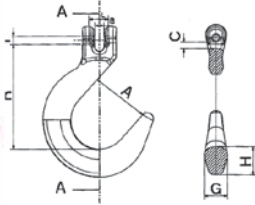
**GENİŞ AĞIZLI KANCA / FOUNDRY CLEVIS HOOK****GRADE 8**

Kod No Art No.	Model	Zincir / Chain		W.L.L. kg	Boyutlar / Dimensions mm							Ağırlık / Weigh kg
		mm	inch		A	B	C	G	H	R	PxL	
58901306	NL-CYF 06	6	1/4	1120	53,5	8,5	6,5	22	26	91	7,5x17,5	0,7
58901308	NL-CYF 08	8	5/16	2000	64	10	11,5	26	31	120,4	9x22,5	1,1
58901310	NL-CYF 10	10	3/8	3150	76	13	15	30	34	131	13x31,5	1,7
58901313	NL-CYF 13	13	1/2	5300	89	17	17,5	40	44,5	148	16x42	3,6
58901316	NL-CYF 16	16	5/8	8000	101	19	21,5	45	50,5	198,5	21x51,5	5,6

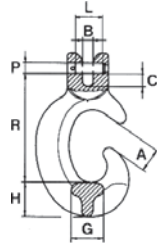
**CT KANCA / CLEVIS GRAB HOOK****GRADE 8**

Kod No Art No.	Model	Zincir / Chain		W.L.L. kg	Boyutlar / Dimensions mm							Ağırlık / Weigh kg
		mm	inch		A	B	C	G	H	R	PxL	
58900508	NL-CT 08	8	5/16	2000	20	9	11	22	27	90	9x22,5	0,56
58900510	NL-CT 10	10	3/8	3150	28	12	14	28	39	129	13x31,5	1,40
58900513	NL-CT 13	13	1/2	5300	39	15	17	35	51	166	16x42	3,00

**GÖVDE MANDALLI KULPLU KANCA / CLEVIS GRIP SAFE LOCKING HOOK****GRADE 100**

Kod No Art No.	Model	Zincir / Chain		W.L.L. kg	Boyutlar / Dimensions mm							Ağırlık / Weigh kg
		mm	inch		A	H	K	O	P	T	W	
57901710	NL-SLX 10	10		4000	11	31	153	49	71	27	139	1,9
57901713	NL-SLX 13	13		6700	14	39	206	57	80	34	174	4,1
57901716	NL-SLX 16	16		10000	18	47	243	78	114	39	212	6,4
57901720	NL-SLX 20	20		16000	21	56	310	91	127	54	250	12,7
57901722	NL-SLX 22	22		19000	24	59	300	105	151	56	260	14,1

**KISALTIMA KANCASI / CLEVIS GRAB HOOK**

**GRADE 8**

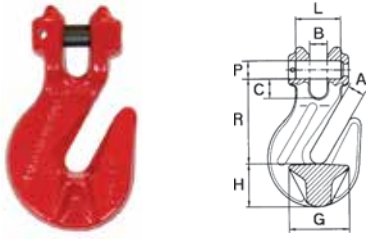

Kod No Art No.	Model	Zincir / Chain		W.L.L. kg	Boyutlar / Dimensions mm								Ağırlık / Weight kg
		mm	inch		A	B	C	G	H	R	PxL		
58901506	NL-CF 06	6	1/4	1120	8	8	8.8	22	22	50.5	7.5x17.5	0.20	
58901508	NL-CF 08	8	5/16	2000	10	9	10	30	24	50	9x22.5	0.27	
58901510	NL-CF 10	10	3/8	3150	13	13	14	44	31	72	13x31.5	0.75	
58901513	NL-CF 13	13	1/2	5300	17	17	17	53	38	88	16x42	1.35	
58901516	NL-CF 16	16	5/8	8000	20	21	20	64	60	111	21x51.5	2.8	

**KISALTIMA APARATI / SHORTENING CLUTCH**

**GRADE 8**

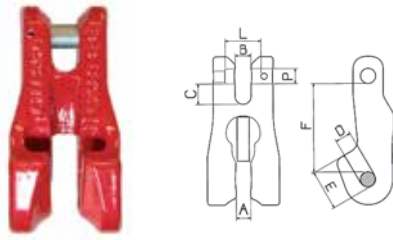

Kod No Art No.	Model	Zincir / Chain		W.L.L. kg	Boyutlar / Dimensions mm								Ağırlık / Weight kg
		mm	inch		A	B	C	D	E	F	PxL		
58900306	NL-CX 06	6	1/4	1120	8	8	10	8	19	45	7.5x17.5	0.21	
58900308	NL-CX 08	8	5/16	2000	9.5	9.5	10	9.5	23.5	56	10x22.5	0.48	
58900310	NL-CX 10	10	3/8	3150	12	12	14.5	12	32.5	78	13x31.5	1.12	
58900313	NL-CX 13	13	1/2	5300	15.5	15.5	18	15.5	44	90	16x42	1.83	
58900316	NL-CX 16	16	5/8	8000	19	21	21	19	50	106	21x51.5	2.83	

**BAĞLANTI ELEMANI / COUPLING LINK**

**GRADE 8**

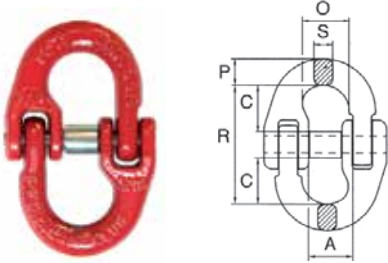

Kod No Art No.	Model	Zincir / Chain		W.L.L. kg	Boyutlar / Dimensions mm							Ağırlık / Weight kg
		mm	inch		A	C	O	R	P	S		
58900406	NL-CL 06	6	1/4	1120	16	18	16.5	43	7.2	6.8	0.07	
58900408	NL-CL 08	8	5/16	2000	19	25.5	23.5	62	11.5	10	0.25	
58900410	NL-CL 10	10	3/8	3150	23.8	30	27.5	72	12.6	12.6	0.35	
58900413	NL-CL 13	13	1/2	5300	28	36	33.3	87.3	19	16.7	0.68	
58900416	NL-CL 16	16	5/8	8000	34.3	40.5	39.5	103	20.6	20.6	1.10	

**POLYESTER SAPAN BAĞLANTI ELEMANI / WEBBING COUPLING LINK**

**GRADE 8**

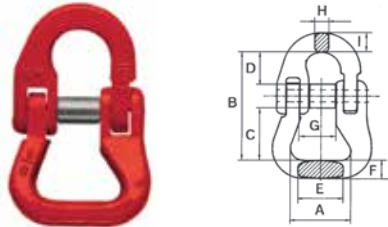

Kod No Art No.	Model	Zincir / Chain		W.L.L. kg	Boyutlar / Dimensions mm									Ağırlık / Weight kg
		mm	inch		A	B	C	D	E	F	G	H	I	
58901408	NL-CLS 08	8	5/16	2000	40	58	24	20	24	14	17	9	10	0.28
58901410	NL-CLS 10	10	3/8	3150	40	81	35	30	30	14	23	11	13	0.47
58901413	NL-CLS 13	13	1/2	5300	55	104	48	36	36	18	28	16	16	0.99
58901416	NL-CLS 16	16	5/8	8000	67	115	57	40	44	24	36	21	21	2.0

**POLYESTER SAPAN KANCASI / HOOK FOR WEB SLING**

**GRADE 8**

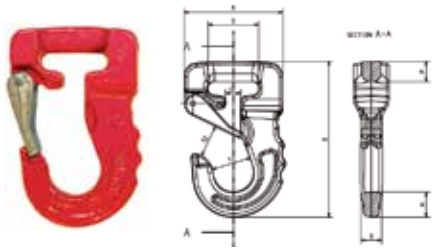

Kod No Art No.	Model	W.L.L. kg	Boyutlar / Dimensions mm										Ağırlık / Weight kg
			A	B	C	D	G	H	P	T	T2		
58900301	NL-CJ 01	1000	78	123	12	41	17	20	16	31	26	0.7	
58900302	NL-CJ 02	2000	91	148	19	55	21	26	17	40	31	1.2	
58900303	NL-CJ 03	3000	113	175	21	55	25	32	25	50	37	2.2	
58900304	NL-CJ 04	4000	133	223	40	70	36	40	36	59.5	43	4.5	
58900305	NL-CJ 05	5000	133	223	40	70	36	40	36	59.5	43	4.5	
58902306	NL-CJ 06	6000	133	223	40	70	36	40	36	59.5	43	4.5	
58902308	NL-CJ 08	8000	188	302	50	105	40	60	42	80	65	9.7	
58902310	NL-CJ 10	10000	188	302	50	105	40	60	42	80	65	9.7	

**KAYNAKLI KANCA / HOOK WELD-ON TYPE**

**GRADE 8**



Kod No Art No.	Model	W.L.L. kg	Boyutlar / Dimensions mm							Ağırlık / Weight kg	Boyutlar / Dimensions mm					
			A	B	C	E	G	L	90° Tek Barak		90° İki Barak	0° - 45° İki Barak	0° - 60° İki Barak	0° - 45° İki Barak	0° - 60° İki Barak	
58901001	NL-805	1120	25	76	59.5	20	25	97	0.7	1.12	2.24	1.57	1.12	2.35	1.68	1.12
58901002	NL-806	2000	26.5	92	65	22	34	114	1.2	2	4	2.8	2	4.2	3	2
58901003	NL-807	3000	29	106	75	24	36	129	2.2	3	6	4.2	3	6.3	4.5	3
58901004	NL-808	5000	34.5	130	92	30	45	171	4.5	5	10	7	5	10.5	7.5	5

## FIRDÖNDÜLÜ BAĞLANTI NOKTASI / ROTATING EYEBOLT WITH RING

GRADE 8

## KAPASİTE TABLOSU / CAPACITY TABLE

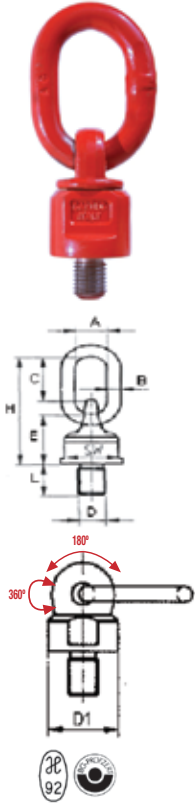

Kod No Art No.	Ölçü/Size mm	W.L.L. †	mm							Ağırlık / Weight kg	Kapasite Tablosu / Capacity Table										
			A	B	C	E	H	SW	D1		0° Tek Bacak	0° İki Bacak	90° Tek Bacak	90° İki Bacak	0-45° İki Bacak	45-60° Asımm	0-45° 3-4 Bacak	45-60° Asımm	Nm		
39500030	M10x18	0.3	30	13	46	50	105	30	38	0.480	0,6	1,2	0,3	0,6	0,42	0,3	0,3	0,63	0,45	0,3	16
39500050	M12x18	0.5	30	13	46	50	105	30	38	0.500	1	2	0,5	1	0,75	0,5	0,5	1,1	0,75	0,5	28
39500052	M12x25	0.5	30	13	46	50	105	30	38	0.500	1	2	0,5	1	0,75	0,5	0,5	1,1	0,75	0,5	28
39500125	M16x20	1.12	30	13	46	50	105	30	38	0.530	2	4	1,12	2	1,5	1,12	1,12	2,36	1,6	1,12	70
39500126	M16x30	1.12	30	13	46	50	105	30	38	0.530	2	4	1,12	2	1,5	1,12	1,12	2,36	1,6	1,12	70
39500150	M20x30	1.12	30	13	46	50	105	30	38	0.530	2	4	1,12	2	1,5	1,12	1,12	2,36	1,6	1,12	135
39500200	M20x30	2	34	16	57	61	131	40	50	1.050	4	8	2	4	2,8	2	2	4	3	2	135
39500300	M24x30	3.15	40	19	70	68	153	48	58	1.630	6,3	12,5	3,15	6,3	4,25	3,15	3,15	6,3	4,75	3,15	230
39500500	M30x35	5.3	40	20	65	80	165	65	75	2.230	10,6	21,2	5,3	10,6	7,1	5,3	5,3	11,2	8	5,3	465
39500502	M30x45	5.3	40	20	65	80	165	65	75	2.230	10,6	21,2	5,3	10,6	7,1	5,3	5,3	11,2	8	5,3	465
39500800	M30x35	8	50	22	90	95	205	75	85	5.300	12,5	25	8	16	11,2	8	8	16,8	12	8	465
39500801	M30x45	8	50	22	90	95	205	75	85	5.300	12,5	25	8	16	11,2	8	8	16,8	12	8	465
39500802	M36x54	8	50	22	90	95	205	75	85	5.500	12,5	25	8	16	11,2	8	8	16,8	12	8	814
39501042	M42x63	10	50	22	90	95	205	75	85	10.000	15	30	10	20	14	10	10	21,2	15	10	1304
39501501	M48x60	15	70	30	120	130	280	95	120	10.000	25	50	15	30	21	15	15	31,5	22,5	15	1981
39501556	M56x78	15	70	30	120	130	280	95	120	10.000	25	50	15	30	21	15	15	31,5	2,5	15	3000
39501564	M64x96	15	70	30	120	130	280	95	120	10.000	25	50	15	30	21	15	15	31,5	22,5	15	4738
39501572	M72x108	25	68	40	127	165	338	134	160	29.000	35	70	25	50	35	25	25	52,5	37,5	25	6913
39501580	M80x120	30	68	40	127	165	338	134	170	29.000	35	70	30	60	42	30	30	63	45	30	9625
39501590	M90x135	35	68	40	127	165	338	134	170	29.000	35	70	35	70	49	35	35	73,5	52,5	35	14000

## BAĞLANTI NOKTASI / EYEBOLT

GRADE 8

## KAPASİTE TABLOSU / CAPACITY TABLE

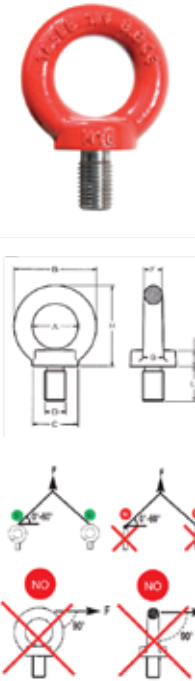

Kod No Art No.	Ölçü/Size (Dış)mm	W.L.L. †	mm						Ağırlık / Weight kg	Kapasite Tablosu / Capacity Table						
			A	B	C	E	F	H		0° Tek Bacak	0° İki Bacak	0-45° İki Bacak	45-60° Asımm	0-45° 3-4 Bacak	45-60° Asımm	Nm
29570006	M6x13	0,4	25	45	25	10	10	45	0,090	0,4	0,8	0,14	0,1	0,2	0,14	3,5
29570008	M8x13	0,8	25	45	25	10	10	45	0,090	0,8	1,6	0,25	0,2	0,4	0,28	8
29570010	M10x17	1	25	45	25	10	10	45	0,110	1	2	0,35	0,25	0,5	0,35	16
29570012	M12x21	1,6	35	63	35	14	14	62	0,270	1,6	3,2	0,56	0,4	0,8	0,56	28
29570014	M14x21	3	35	63	35	14	14	62	0,290	3	6	1	0,75	1,5	1	45
29570016	M16x27	4	35	63	35	14	14	62	0,310	4	8	1,4	1	2	1,4	70
29570018	M18x27	5	50	90	50	20	20	90	0,840	5	10	1,8	1,25	2,5	1,8	95
29570020	M20x30	6	50	90	50	20	20	90	0,860	6	12	2,1	1,5	3	2,1	135
29570022	M22x36	7	50	90	50	20	20	90	0,900	7	14	2,4	1,75	3,5	2,4	182
29570024	M24x36	8	50	90	50	20	20	90	0,900	8	16	2,8	2	4	2,8	230
29570027	M27x45	10	60	108	65	24	24	109	1,660	10	20	3,5	2,5	5	3,5	343
29570030	M30x45	12	60	108	65	24	24	109	1,700	12	24	4,2	3	6	4,2	465
29570033	M33x54	14	70	126	75	26	28	128	2,000	14	28	4,8	3,4	6,8	4,8	632
29570036	M36x54	16	70	126	75	26	28	128	2,150	16	32	5,6	3,9	7,8	5,4	814
29570042	M42x63	24	80	144	85	30	32	147	4,150	24	48	8,4	5,9	11,8	8,2	1304
29570048	M48x68	32	90	166	100	35	38	168	6,200	32	64	11,2	7,8	15,6	10,9	1981
29570056	M56x78	36	100	184	110	38	42	187	8,800	36	72	12,6	8,8	17,6	12,3	3000
29570064	M64x90	45	110	206	120	42	48	208	12,400	45	90	15,7	11	22	15,4	4736

EMNİYET MANDALLI KANCA KİTİ /  
LATCH KIT FOR HOOKS

Kod No Art No.	Model	Zincir / Chain	
		mm	inch
Y109201010	NL-CKS 06	6	1/4
Y109201011	NL-CKS 08	8	5/16
Y109201012	NL-CKS 10	10	3/8
Y109201013	NL-CKS 13	13	1/2
Y109201014	NL-CKS 16	16	5/8

GÖVDE MANDALLI KANCA KİTİ /  
LOCKING SYSTEM KIT FOR  
SELF LOCKING HOOKS

Kod No Art No.	Model	Zincir / Chain	
		mm	inch
Y109201015	NL-CKSL 06	6	1/4
Y109201016	NL-CKSL 08	8	5/16
Y109201017	NL-CKSL 10	10	3/8
Y109201018	NL-CKSL 13	13	1/2
Y109201019	NL-CKSL 16	16	5/8

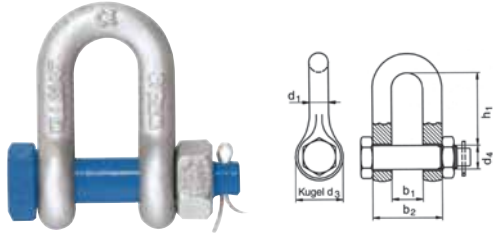

**EMNİYET SOMUNLU U MAPALAR / SHACKLE HIGH TENSILE U FORM LOCK NUT**

Kod No Art No.	Ölçü / Dimension ns	W.L.L. t	Ölçüler / Dimensions mm							Ağırlık / Weight kg
			b1	b2	d1	d4	h1	d3		
25541005	1/4"	0,500	12	26	6	8	22	17	0,06	
25541007	5/16"	0,750	13	29	8	10	26	21	0,10	
25541010	3/8"	1,000	16	36	10	12	31	26	0,15	
25541015	7/16"	1,500	18	40	11	14	36	28	0,22	
25541020	1/2"	2,000	21	47	13	16	41	30	0,34	
25541032	5/8"	3,250	27	59	16	19	51	42	0,70	
25541047	3/4"	4,750	32	70	19	22	60	48	1,18	
25541065	7/8"	6,500	36	80	22	25	71	57	1,64	
25541085	1"	8,500	43	93	25	28	81	62	2,41	
25541095	1 1/8"	9,500	46	104	29	32	90	69	3,27	
25541120	1 1/4"	12,000	52	116	32	35	100	78	4,59	
25541135	1 3/8"	13,500	57	127	35	38	113	86	6,00	
25541170	1 1/2"	17,000	60	136	38	42	124	94	8,33	
25541250	1 3/4"	25,000	73	161	44	50	146	112	12,83	
25541350	2"	35,000	83	185	51	55	171	127	19,30	
25541500	2 1/2"	55,000	105	232	64	70	203	152	34,50	
25541851	3"	85,000	127	279	76	82	216	200	60,00	
25541121	3 1/2"	120,000	133	317	89	95	253	203	93,00	
25541151	4"	150,000	140	348	102	107	250	226	145,00	

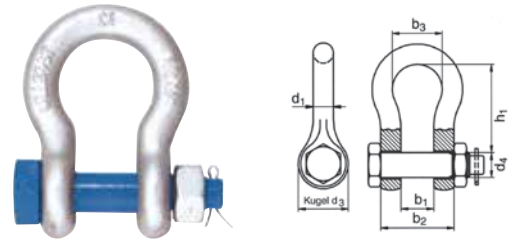

**EMNİYET SOMUNLU OMEGA MAPALAR / SHACKLE HIGH TENSILE OMEGA FORM LOCK NUT**

Kod No Art No.	Ölçü / Dimension ns	W.L.L. t	Ölçüler / Dimensions mm							Ağırlık / Weight kg
			b1	b2	b3	d1	d3	d4	h1	
25543005	1/4"	0,500	12	25	19	6	17	8	28	0,07
25543007	5/16"	0,750	13	29	21	8	21	10	31	0,10
25543010	3/8"	1,000	16	36	26	10	26	12	36	0,18
25543015	7/16"	1,500	18	40	29	11	28	14	42	0,25
25543020	1/2"	2,000	21	47	33	13	30	16	48	0,37
25543032	5/8"	3,250	27	59	43	16	42	20	60	0,71
25543047	3/4"	4,750	32	70	51	19	48	22	71	1,27
25543065	7/8"	6,500	36	80	58	22	57	27	84	1,78
25543085	1"	8,500	43	93	68	25	62	28	95	2,52
25543095	1 1/8"	9,500	46	104	74	29	69	33	103	3,53
25543120	1 1/4"	12,000	52	116	82	32	78	36	119	5,04
25543135	1 3/8"	13,500	57	127	92	35	86	39	133	6,84
25543170	1 1/2"	17,000	60	136	98	38	94	42	146	8,78
25543250	1 3/4"	25,000	73	161	127	44	112	52	178	14,09
25543350	2"	35,000	83	185	146	51	135	60	197	20,90
25543500	2 1/2"	55,000	105	232	184	64	152	70	267	39,90
25543850	3"	85,000	127	279	200	76	200	82	330	62,00
25543121	3 1/2"	120,000	137	321	232	92	220	95	374	109,00
25543151	4"	150,000	145	353	250	104	240	108	372	130,00

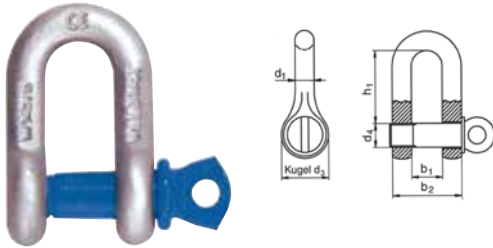

**PİMLİ U MAPALAR / SHACKLE HIGH TENSILE U FORM WITH PIN**

Kod No Art No.	Ölçü / Dimension ns	W.L.L. t	Ölçüler / Dimensions mm							Ağırlık / Weight kg
			b1	b2	d1	d4	h1	d3		
25540005	1/4"	0,500	12	26	6	8	22	17	0,05	
25540007	5/16"	0,750	13	29	8	10	26	21	0,08	
25540010	3/8"	1,000	16	36	10	12	31	26	0,13	
25540015	7/16"	1,500	18	40	11	14	36	28	0,19	
25540020	1/2"	2,000	21	47	13	16	41	30	0,31	
25540032	5/8"	3,250	27	59	16	20	51	42	0,55	
25540047	3/4"	4,750	32	70	19	22	60	48	0,96	
25540065	7/8"	6,500	36	80	22	27	71	57	1,41	
25540085	1"	8,500	43	93	25	30	81	62	2,03	
25540095	1 1/8"	9,500	46	104	29	33	90	69	2,97	
25540120	1 1/4"	12,000	52	116	32	36	100	78	4,01	
25540135	1 3/8"	13,500	57	127	35	39	113	86	5,40	
25540170	1 1/2"	17,000	60	136	38	42	124	94	7,29	
25540250	1 3/4"	25,000	73	161	44	52	146	112	11,25	
25540350	2"	35,000	83	185	51	60	171	135	16,20	
25540550	2 1/2"	55,000	106	232	63	72	203	158	33,30	

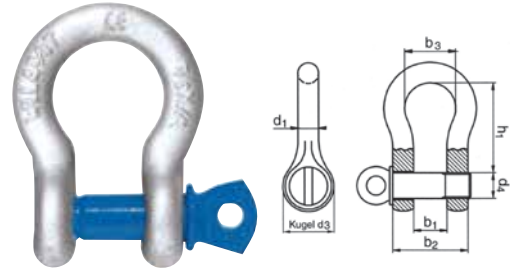

**PİMLİ OMEGA MAPALAR / SHACKLE HIGH TENSILE OMEGA FORM WITH PIN**

Kod No Art No.	Ölçü / Dimension ns	W.L.L. t	Ölçüler / Dimensions mm							Ağırlık / Weight kg
			b1	b2	b3	d1	d3	d4	h1	
25542005	1/4"	0,500	12	25	19	6	17	8	28	0,05
25542007	5/16"	0,750	13	29	21	8	21	10	31	0,08
25542010	3/8"	1,000	16	36	26	10	26	12	36	0,14
25542015	7/16"	1,500	18	40	29	11	28	14	42	0,22
25542020	1/2"	2,000	21	47	33	13	30	16	48	0,33
25542032	5/8"	3,250	27	59	43	16	42	20	60	0,65
25542047	3/4"	4,750	32	70	51	19	48	22	71	0,97
25542065	7/8"	6,500	36	80	58	22	57	27	84	1,46
25542085	1"	8,500	43	93	68	25	62	28	95	2,39
25542095	1 1/8"	9,500	46	104	74	29	69	33	103	3,15
25542125	1 1/4"	12,000	52	116	82	32	78	36	119	4,32
25542135	1 3/8"	13,500	57	127	92	35	86	39	133	5,67
25542170	1 1/2"	17,000	60	136	98	38	94	42	146	7,79
25542250	1 3/4"	25,000	73	161	127	44	112	52	178	12,51
25542350	2"	35,000	83	185	146	51	135	60	197	18,50
25542550	2 1/2"	55,000	106	232	184	63	158	72	267	37,58

**Standart** : U.S. Fed. Spec. RR-C-271 - EN 10204 - 3.1B  
**Malzeme** : Yüksek mukavemetli çelik, söndürülmüş ve tavlanmış, Grade 6

**Finish** : Tüm parçalar sıcak daldırma, galvanizleme sonrası vida/pim üzeri mavi boyalı  
**Emniyet Faktörü** : 6.0  
**Dökümantasyon** : Test sertifikası